



*Image for illustration only - see specification within for dimensions and labelling

TOCSIN 750 SERIES

HMI Based Detector Control Panel

Operation, Maintenance and Safety Instruction Manual

V6.0

Table of Contents

Specification	4		
System Example	5		
Overall Dimensions	7		
Interface Wiring			
Highway Hub Controller Overview	9		
Relay Card Overview	10		
Modbus	12		
Operating System		Module Setup Functions	
Overview	14	Connection Possibilities	38
Special States	15	Forcing a Channel Input	40
Alarm display Mode	16	Backing UP Panel Setup Internally	41
Warmup - Inhibit	17	Power Function	41
Fault States	18	Modbus Settings	43
Setup Sequence	19	GSM Module Functions	44
System Menu's	20		45
Engineers Menu	20	Troubleshooting	50
System Menu - Access Options	21	Standard Accessories Supplied	51
Operational Set up Philosophy	22		
Sensor FIND Function	24		
Sensor Setup	24	Help Section	
Sensors Test Function	25		
Sensor Diagnostics	27		
The Relay Tab	28		
Relay Comms Test Function	29		
Relay Diagnostics Function	30		
Relay Function Test	31		
The Alarms Tab	32		
The Alarm Relay Setup Menu	33		
Calibration Menu Tab	34		
The Sensor ZERO Function	34		
The Sensor CALIBRATE Function	37		

Brief Introduction

The Tocsin 750 control panel uses the latest technology 2-wire addressable highways to control gas detectors and associated accessories. Providing an extremely flexible and low cost solution.

Main Features

750 Series

Up to 350 Detectors and I/O Points

Internal or External Battery Backup

2 Core Cable Connection (No Polarity)

Colour Touch Screen

Service & Maintenance

It is recommended that control panels and all connected detectors are commissioned upon installation and serviced every 6 months by an IGD trained technician. IGD can offer full training to enable your staff to do the servicing or offer a competitive service from our fleet of service engineers. Whilst detectors are supplied pre-calibrated this does not obviate the need to use test gases during commissioning to prove correct operation.

Warnings and Performance Statements

This control panel is NOT to be located in a classified Ex area, devices installed in an Ex area can be connected to this unit but shall be protected with one of the types of protection listed in IEC 60079-0 corresponding to their own category. We recommend users read the procedures described in IEC 60079-29-2 for reference. The controller is intended for indoor use and can only be used outside when fitted into a suitable IP rated IGD field enclosure.

This product must be earthed in accordance with local safety regulations. A switch or circuit breaker must be included in the installation; it must be suitably located; easily reached and it must be marked as the disconnect device for the equipment.

The Control Panel leaves the factory configured for the supply voltage stated on the customers order. Standard options are indicated in the basic specifications on page 4

Should the control panel be used in conjunction with portable generating equipment, care should be taken to ensure that the electrical supply is within the tolerance band described above.

The control panel may be stored at temperatures between -25°C and 60°C . If stored at low temperatures and then brought into a warmer environment care should be taken to ensure that condensation does not form or enter critical electrical components, for example the power supply. Allow 24 hours to stabilise extremes of temperature.

The Control Panel is designed to operate within specification for ambient temperature between -20°C and 55°C , relative humidity up to 90% (non-condensing). Sensor specifications may differ.

Do not use a Control Panel for protection applications that has not been calibrated. If calibration seals are missing from the control panel or have been tampered with or broken, then the control panel must be re-calibrated and sealed by a trained engineer.

Substances and interfering gases can cause adverse effects on the performance or electrical safety of the gas detection systems. Care should be taken to limit exposure to these poisoning substances, for further advice and information contact head office

The response time of the entire system is determined by the time of response of all the parts of the equipment within the gas detection system.

The relationship between the output signal and the gas concentration is linear, the control panel interprets the signal and the gas level is displayed on the HMI display. IGD hold evidence of this linear performance which is available upon request.

Basic Specification

150W PSU @ 230VAC Nominal	190 to 260V AC 50/60Hz by selection
Ambient Operating Temperature	-20 to +55 Degrees Centigrade
Ambient Operating Humidity	20-90% RH Non-Condensing (see sensor data)
Protection	IP54 according to IEC 60529 IP ratings do not imply that the equipment will detect gas during and after exposure to these conditions. Calibration and maintenance may be required more frequently and should be assessed based upon exposure.
Maximum Altitude	2000m
Usage	Indoor use
Overvoltage Catagory	OVC II
Pollution Degree	PD 2
Display	7" Full Colour Touch Screen 800 x 480
Displayed Detector Resolution (Range Dependant)	1% LEL 1%Vol 0.1% Vol 1 ppm 0.1ppm
External Interface	Modbus
Connected devices	Up to 128 Devices on single hub max 350 input channels including ancillary I/O ports
Pressure Limits	800 to 1200mbar (80 to 120kPa)
Max Altitude	2000M
Warm up time	15 minutes (Systems with Oxygen Sensors) 5 Minutes Standard
Max Power Consumption	150 Watts
Air Velocity	0-6m/s. refer to installers guide for allowable orientation
EMC Compatibility	see installer guide

System Example

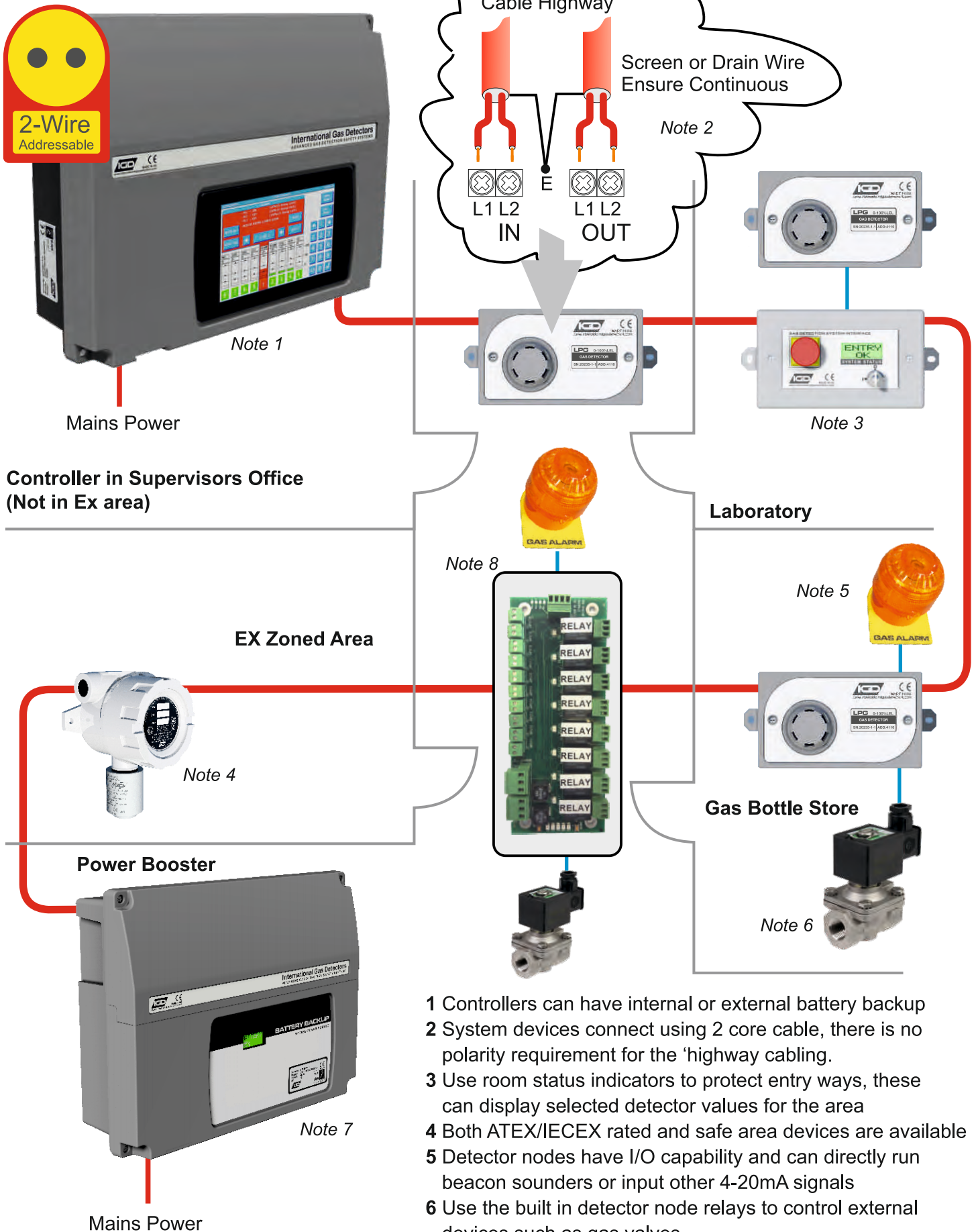

- 1 Controllers can have internal or external battery backup
- 2 System devices connect using 2 core cable, there is no polarity requirement for the 'highway cabling'.
- 3 Use room status indicators to protect entry ways, these can display selected detector values for the area
- 4 Both ATEX/IECEx rated and safe area devices are available
- 5 Detector nodes have I/O capability and can directly run beacon sounders or input other 4-20mA signals
- 6 Use the built in detector node relays to control external devices such as gas valves
- 7 Power modules are available for larger systems
- 8 Fit i/o cards on the same highway where control is required



Important Notes

Gas detection systems must be correctly specified, installed and maintained in order to be effective. Anyone undertaking elements of this work should have access to the necessary equipment and be able to demonstrate competence. This will usually mean having passed a training competency course. International Gas Detectors run training courses for safety survey, specification, installation and service aspects of hazardous gas detection systems. In addition IGD can supply test equipment and calibration gases necessary to undertake this work.

Please the following points

1. A zero grade gas usually instrument air or Nitrogen and a suitable calibration gas mixture is required.
2. The correct gas adaptors must be used to apply gases to detectors when zeroing and calibrating. Incorrect application of gases can affect calibration results
3. Use equipment and gases traceable to a national standard. Any calibration will only be as good as the equipment and materials used.
4. IGD supply fixed flow regulators for use with IGD calibration gas bottles which supplies gas at 0.5L/Min

Panel Options

Part Number	Description	Available Accessories for use with the TOCSIN 750
TOC-750-150	110/230V AC Control Panel 150W PSU Standard Features including HMI Display 4 Relays, 4 Highways	 <p>TOCSIN 750 Series Annunciator Options With: Display, Relay Output, Digital or Analogue Input, Flammable Gas Detector</p>
		 <p>TOCSIN 750 Series Detectors Flammable Gases, Toxic Gases Oxygen</p>
		 <p>TOCSIN 102 Series Detectors 2-WIRE Flammable Gases, Toxic Gases Oxygen For ATEX Applications</p>

General

Note cables run with modules sequentially wired.

Power can be taken from system modules for small current devices such as LED beacon sounders and is limited to 100mA per module

Highways are fused at 2A, observe load calculations when planning, use boosters where necessary

Observe interface requirements for relays, fitting freewheel diodes and snubbers as indicated

End of line terminators, supplied with panels must be fitted for correct operation

Tocsin 750 Physical

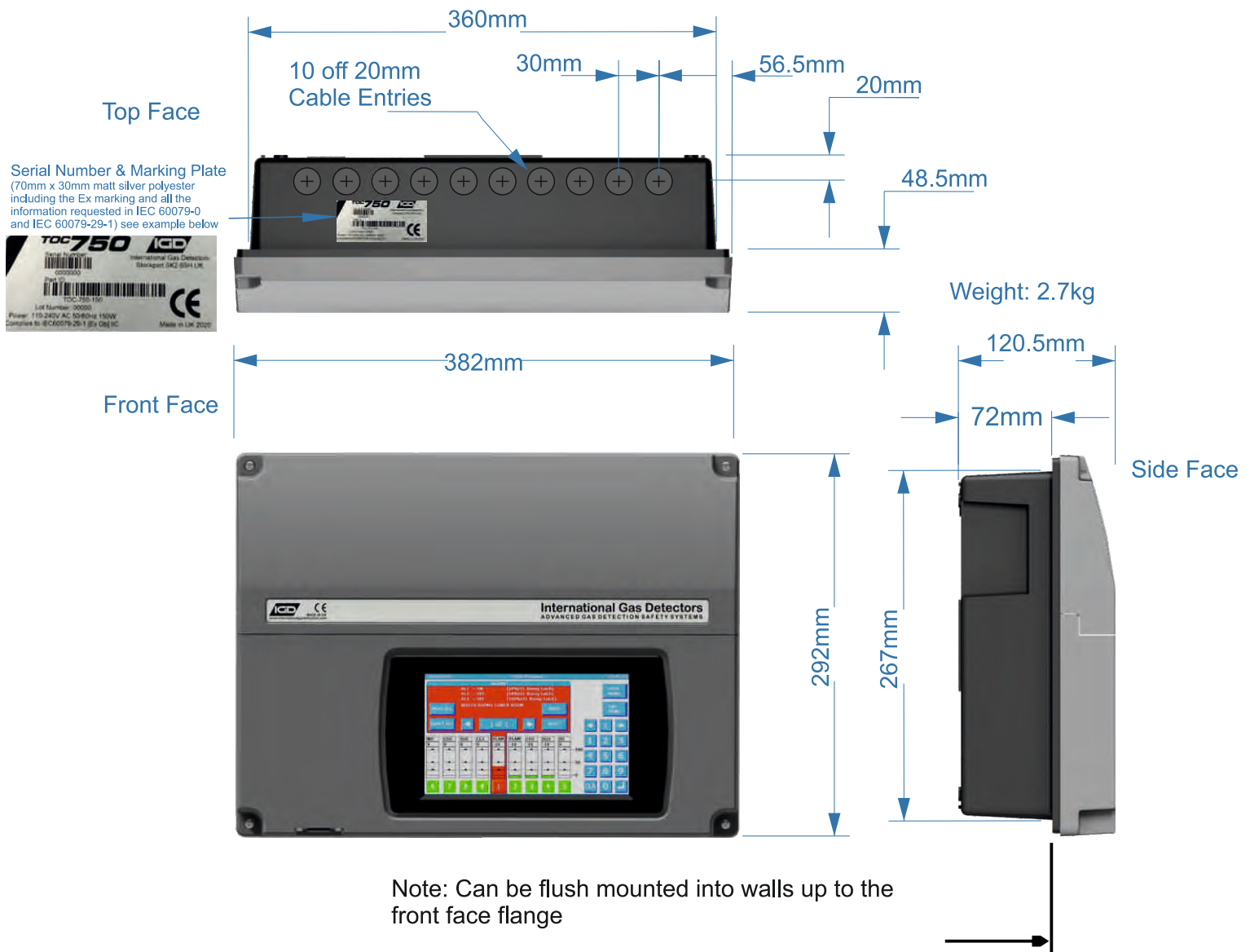

Installation Cables

Supported Installation Cables 2 Core 1.5mmSQ or 2.5mmSQ See IGD Cable System Calculator

Typically SWA, FP200, CY, System cables must be screened, refer to installers guide

Installation Guide

Your 750 Series control panel has been supplied with a separate installation guide. Please read this before installing your system. The Installation guide provides information for correct cable selection, how to correctly install cables and devices and ensure correct cable segregation. It is important to read and understand this document prior to installation.

Copies of the installation guide are available in the downloads section of our website. Always check you are using the latest versions of the supplied manuals by checking on the IGD website.

Failure to follow correct installation may result in poor performance and/or damage to system components.



IGD-Academy

IGD's On-Line training academy is available to support your companies activities. The Academy features a range of CPD approved training courses and 'how to' videos.

The academy can be found at: <https://igdacademy.internationalgasdetectors.com>

Please note that some courses are only available on a request basis. If you require a request only course please email sales@internationalgasdetectors.com to request your account and course.

T750 Control Panel & 2 Wire Hub Controller PCB Features

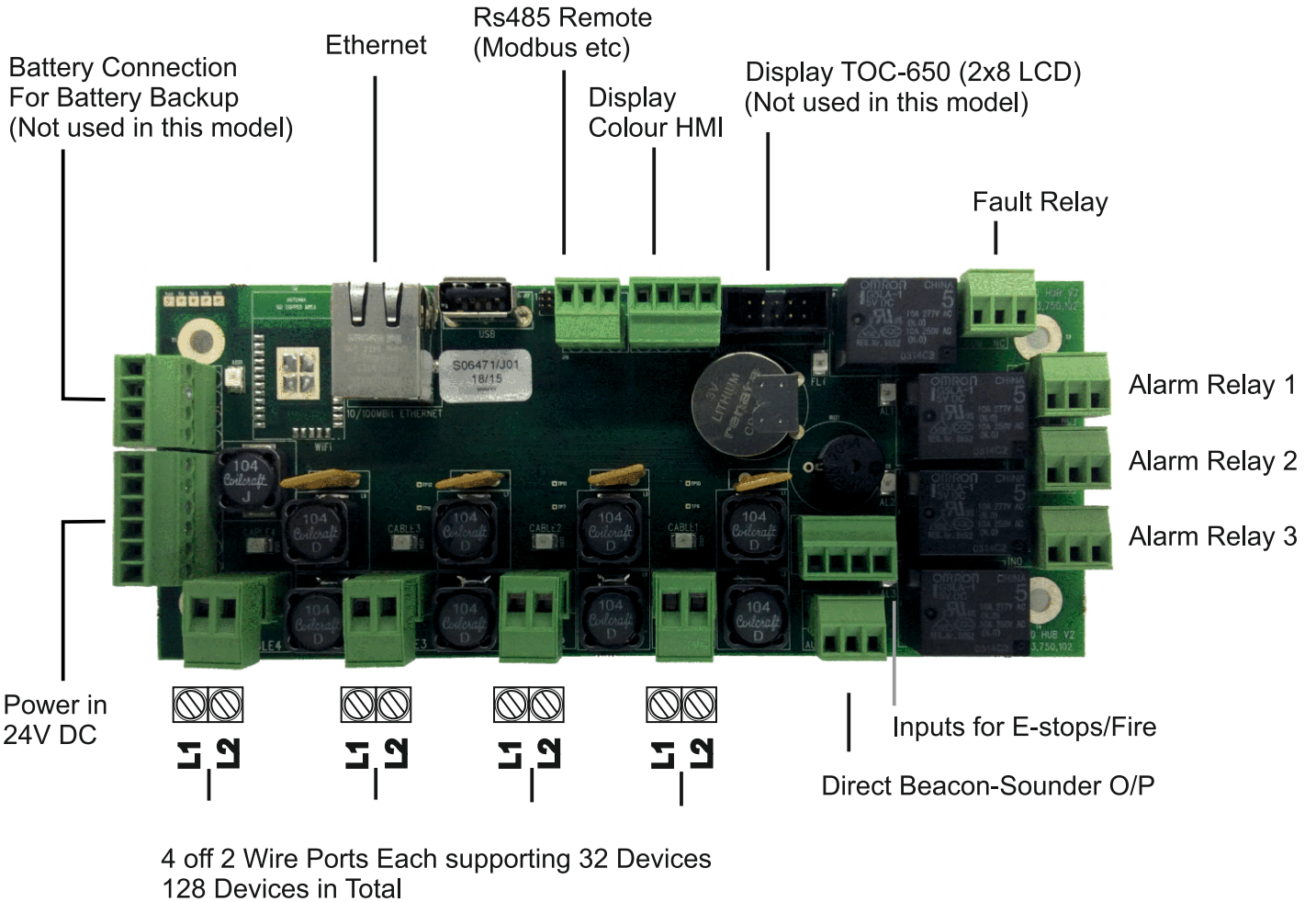

Notes

Tocsin 750 Addressable Relay Card Setting Relay Addresses

Each Addressable relay card must have its own unique base address. This can be set on the card and is indicated below. The relays are then addresses/numbered from that base address. The example below shows a card with a default base address of 101

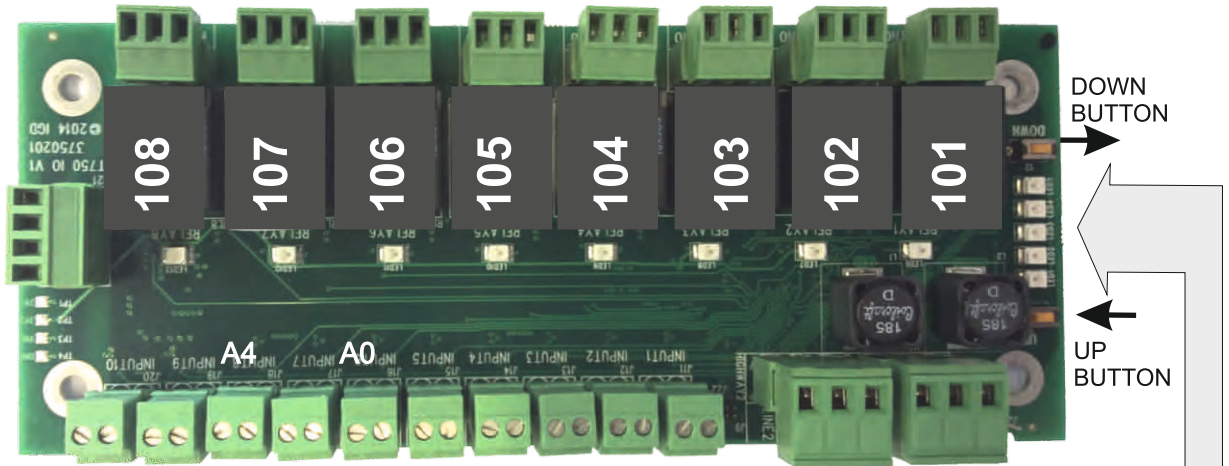

Press and hold the DOWN button until all LED's are OFF. Release the button and the address currently set will be illuminated on the bottom five LED's.

Use the UP and DOWN buttons to alter the address set as indicated in the table below

To exit press and hold UP or DOWN button until all LED's are off then release.

1	2	3	4	5		1	2	3	4	5	
					100					☼	116
☼					101	☼				☼	117
	☼				102		☼			☼	118
☼	☼				103	☼	☼			☼	119
		☼			104			☼		☼	120
☼		☼			105	☼		☼		☼	121
	☼	☼			106		☼	☼		☼	122
☼	☼	☼			107	☼	☼	☼		☼	123
			☼		108				☼	☼	124
☼			☼		109	☼			☼	☼	125
	☼		☼		110		☼		☼	☼	126
☼	☼		☼		111	☼	☼		☼	☼	127
		☼	☼		112			☼	☼	☼	128
☼		☼	☼		113	☼		☼	☼	☼	129
	☼	☼	☼		114		☼	☼	☼	☼	130
☼	☼	☼	☼		115	☼	☼	☼	☼	☼	131

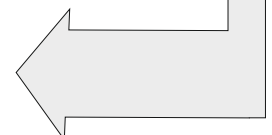

NOTE: WHEN SETTING ADDRESSES YOU CANNOT HAVE TWO DEVICE ADDRESSES SET THE SAME ON THE SAME ADDRESSABLE HIGHWAY or DEVICE.

Tocsin 650/750 Addressable I/O Card Input Ports

Relay cards also have analogue and digital inputs that can be used to read data onto the system from external devices. Setup of the inputs, type, range, addressing etc is controlled via IGD's Android Apps. Wiring options are indicated below. Note the differences between Version 1 and 2 PCB assemblies.

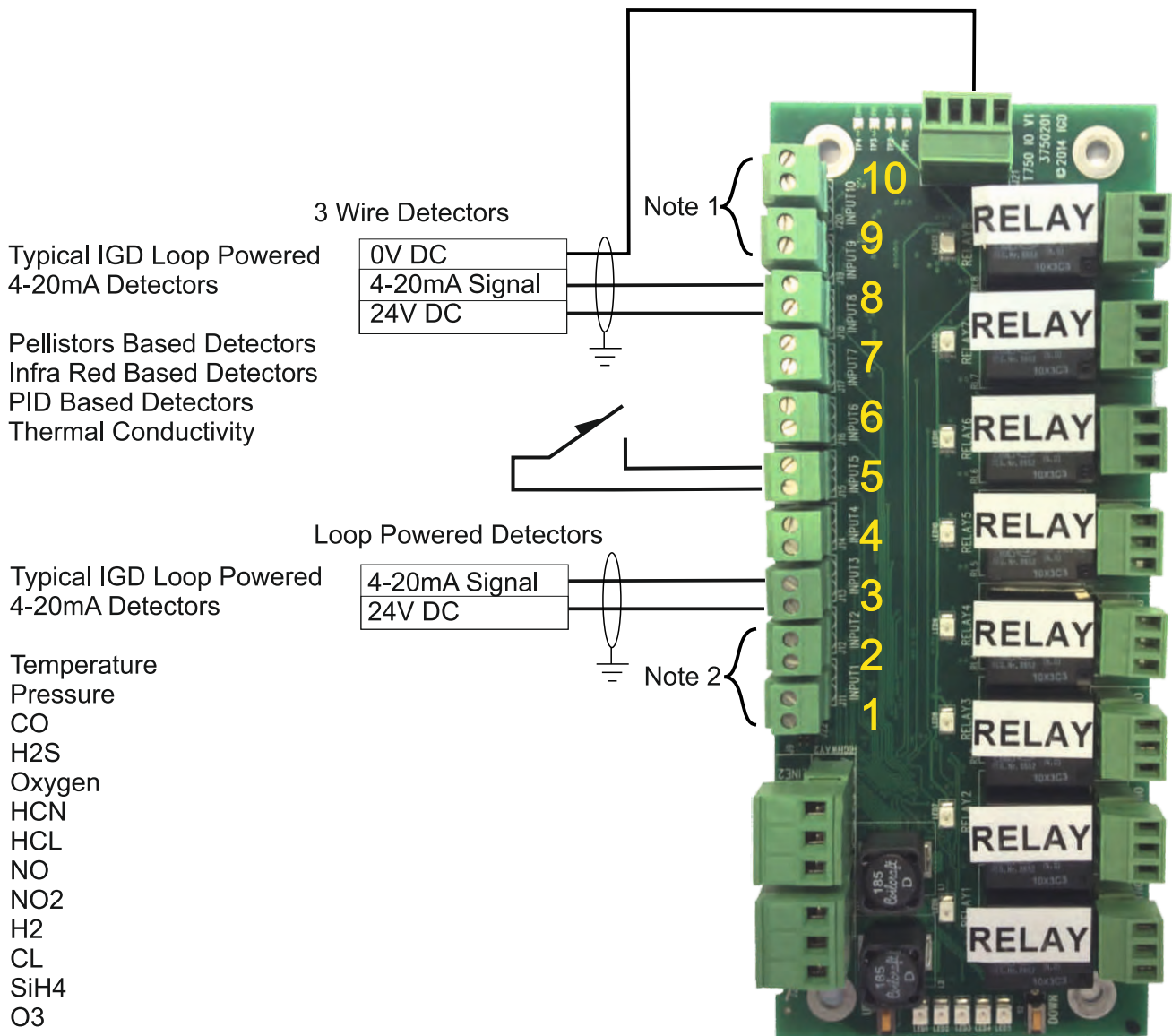

Note 1 These Ports are designated to be digital inputs only.

Note 2 These Ports are not used on version 1 PCB assemblies limiting the PCB to a maximum of 6 analogue inputs or 8 digital inputs including ports 9 and 10.

Note 3 If extended 4-20mA devices are connected, they maybe floating ground type.

Interfacing to the Remote Modbus Port

The Tocsin 640 controller has an in-built memory map allowing access to alarm status, panel status, readings etc using Modbus RTU protocol. Wiring between units is as follows:

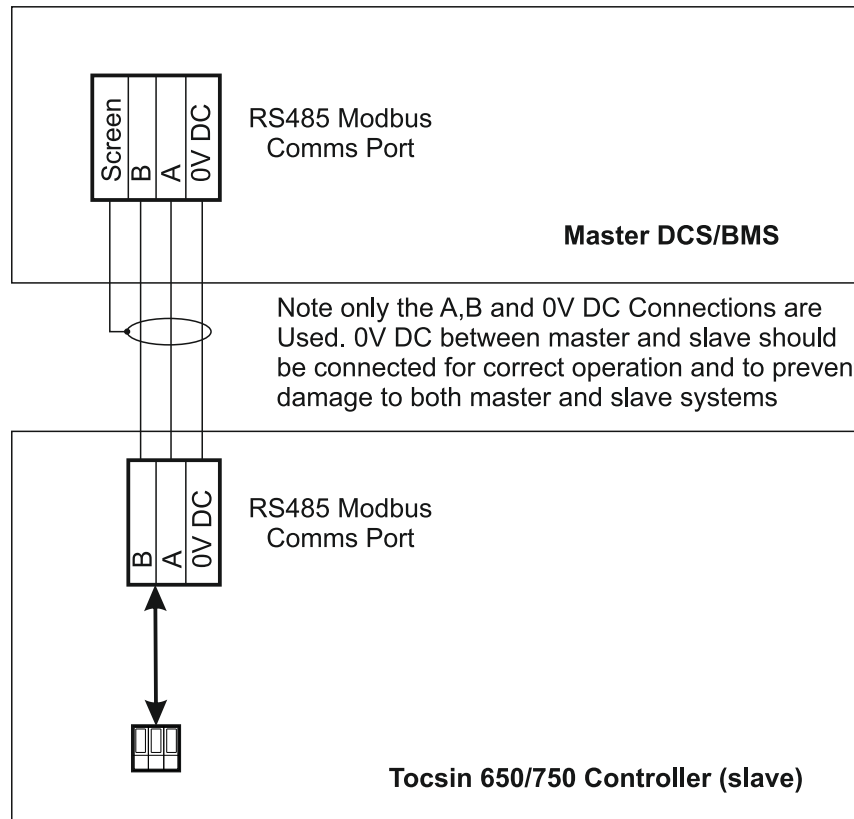

MODBUS INTERNAL MEMORY MAP ADDRESSES

COMMAND STRUCTURE

Parameter	Setting
1: Modbus Mode	RTU Mode Only
2: Operating Mode	Slave Mode Only
3: Response Time ^{#1}	Maximum = 100mS (5s for Zero Command)
4: Requests	Maximum = 32 per Second
5: Panel Address	100 to 131 (100=default)
6: Baud Rate	4800, 9600, 19200 (19200=default)
7: Start Bits	1
8: Data bits	8
9: Parity	None, Odd, Even (Odd=default. None=T700 only)
10: Stop	1, 2 (1=default & T700 only)
11: Flow Control	None
12: Physical Interface	2 Wire RS232, 2 Wire RS485 (2 Wire RS485=Optional on T900)
13: Bit Order	Least significant bit transmitted first
14: Byte Order	Least significant byte transmitted first
15: Inter-byte spacing	Maximum = 1.5 bytes times (781uS @ 19200 Baud)
16: Inter-packet spacing	Minimum = 3.5 bytes times (1823uS @ 19200 Baud)

MODBUS INTERNAL MEMORY MAP ADDRESSES

FUNCTIONS:

Command	Function	Register	Sensor	Returned Word
Read Sensor Conc	04	30,001 to 30,999	1 to 999	Min = 0 (-10% LEL) Max = 1200 (110% LEL) Resolution = 0.1%
Read Sensor Volts	04	31,001 to 31,999	1 to 999	Min = 0 (0.00V) Max = 500 (5.00V) Resolution = 0.01V
Read Area Status (T700 = Common Alarms)	04	32,001 to 32,999	AREA 1 to 999	Bit0 = AL1 Bit1 = AL2 Bit2 = AL3 Bit3 = Fault Bit4 = Sensor Disabled Bit5 – Bit15 = Spare
Read Sensor Status	04	33,001 to 33,999	1 to 999	Bit0 = AL1 Bit1 = AL2 Bit2 = AL3 Bit3 = Fault Bit4 = Sensor Disabled Bit5 = Sensor Fault Bit6 = Under Range Fault Bit7 = Over Range Fault Bit8 = Comms Fault Bit9 = Spare Bit10 = Spare Bit11 = Spare Bit12 = Spare Bit13 = AL1 Muted Bit14 = AL2 Muted Bit15 = AL2 Muted
Mute all Alarms	05	1	ALL	Pass = 0 Fail = 1
Reset all Alarms	05	2	ALL	Pass = 0 Fail = 1
Disable Sensor	05	1,001 to 1,999	1 to 999	Pass = 0 Fail = 1
Enable Sensor	05	2,001 to 2,999	1 to 999	Pass = 0 Fail = 1
Zero Sensor	05	3,001 to 3,999	1 to 999	Pass = 0 Fail = 1
Set Add. Relay = On	05	4,201 to 4,232	4201 to 4232	Pass = 0 Fail = 1,2,3 (1=Timeout, 2=Already Used, 3=Not Implemented)
Set Add, Relay = Off	05	5,201 to 5,232	4201 to 4232	Pass = 0 Fail = 1,2,3 (1=Timeout, 2=Already Used, 3=Not Implemented)

Operating System

On powering of the system, there is an initial count down to allow detectors time to stabilise. This period can be configured in the engineers menu options to suit particular applications. During this warm up period all alarms are inactive.



After the countdown period the system goes into normal monitoring operation.

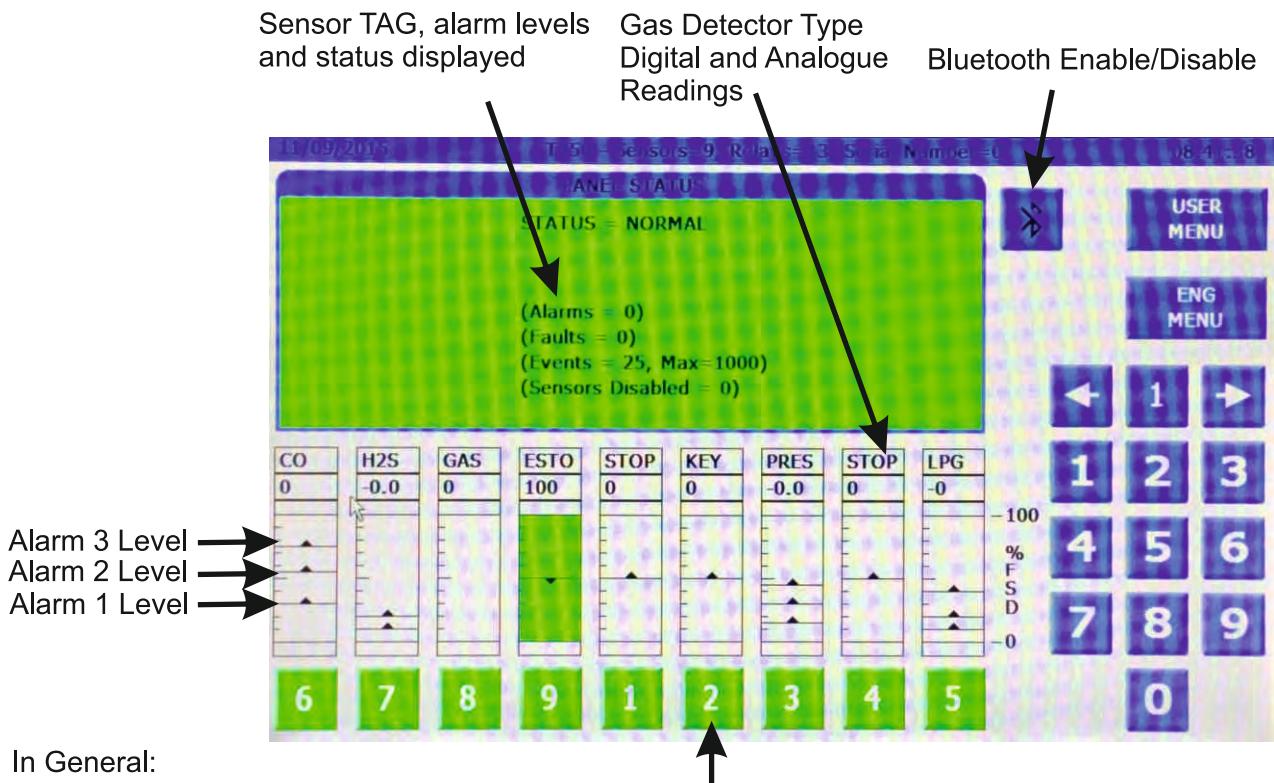

In General:

- Green = Normal
- Red = Alarm
- Yellow = Fault
- Black = Disabled

Click on a displayed channel number to make it the currently viewed channel or type in the channel number of interest. Note that the display centres on the selected channel and displays its current status

Special Status States

State	Indication	State
Warm up	On Screen Count Down 'Blue'	Modbus State Available* Fault Relay Normal Alarm Relays Normal
Fault Communication	Comms Error Displayed 'Yellow'	Modbus State Available* Fault Relay Active Alarm Relays Normal
Fault Over Range	Channel/Display Indication Yellow	Modbus State Available* Fault Relay Active Alarm Relays Normal
Fault Under Range	Channel/Display Indication Yellow	Modbus State Available* Fault Relay Active Alarm Relays Normal
Fault Failed Self Test Processor Voltage	On Screen Display Indication Yellow	Modbus State Available* Fault Relay Active Alarm Relays Normal
Fault Failed Self Test Flash Memory	On Screen Display Indication Yellow	Modbus State Available* Fault Relay Active Alarm Relays Normal
Fault Failed Self Test RAM	On Screen Display Indication Yellow	Modbus State Available* Fault Relay Active Alarm Relays Normal
Alarm 1, 2, or 3 Active	On-Screen Red Alarm 1, 2, or 3 Active Display Each Channel in Alarm	Alarm Relay 1, 2, or 3 Active** Modbus State Available* Fault Relay Normal
Zero/Calibration in Progress	Calibration in Progress	Modbus State Available* Fault Relay Normal Alarm Relays Normal
Inhibit Controller	On-Screen Blue	Modbus State Available* Fault Relay Normal Alarm Relays Normal
Output Test	On-Screen Blue	Modbus State Available* Fault Relay Normal Alarm Relays Normal

* See Modbus information for available registers and options

** Alarm Relays can be setup via the controller software, see alarm options. Each channel on the system will automatically have at the least an alarm level one. This is not optional

The following Pages indicate some of these special states and how they are displayed

System Display When in Alarm

If beacons and sounders are connected using detector nodes then the sounders can be muted.

Note that if alarms are set as latching there are also options to try and reset just this channel or all channels that are in alarm. To reset a latching alarm you must be below the alarm level.

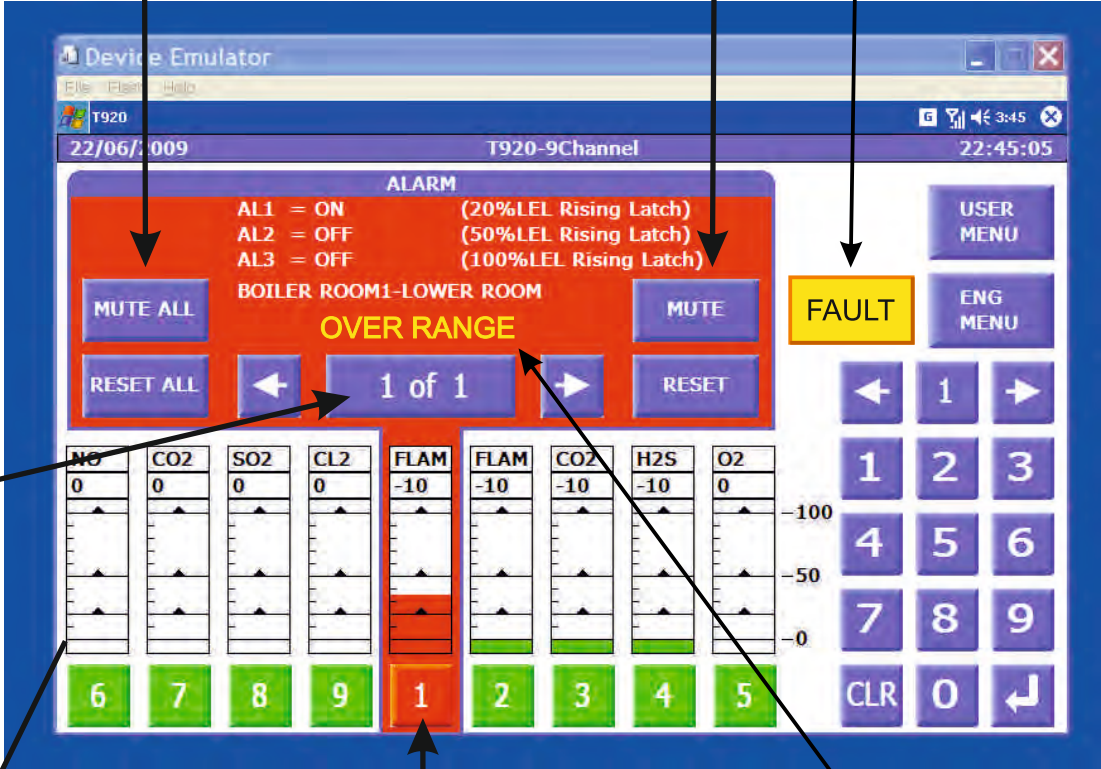

The number of active alarms is displayed. Use the left and right keys to select between channels in alarm.

when the system goes into alarm the display immediately selects the first channel that went into alarm to be the current channel. Note Alarms take precedence over any system faults. An Amber FAULT indicator appears in the event of any panel faults as indicated above.

Channel will Flash Over Range if the Measurement Range is exceeded

Bar Graph Alarm Level Indicators

Gas levels must exceed an alarm level for the alarm to become active. A delay before alarm can be set in the engineer menu and is common in ventilation applications to introduce additional hysteresis into a system.

- 

Rising Latching Alarm Level
Note Latching Alarms Stay Active After The Gas Level Has Gone and Must be Physically Reset
- 

Rising Alarm Level
Rising Alarms Automatically Reset Themselves After The Gas Level Has Gone
- 

Falling Alarm Level
(Typically for Oxygen Depletion Alerts)
Falling Alarms Automatically Reset Themselves After The Gas Level Has Gone
- 

Falling Latching Alarm Level
Note Latching Alarms Stay Active After The Gas Level Has Gone and Must be Physically Reset

System Display During Stabilisation (Warm Up)

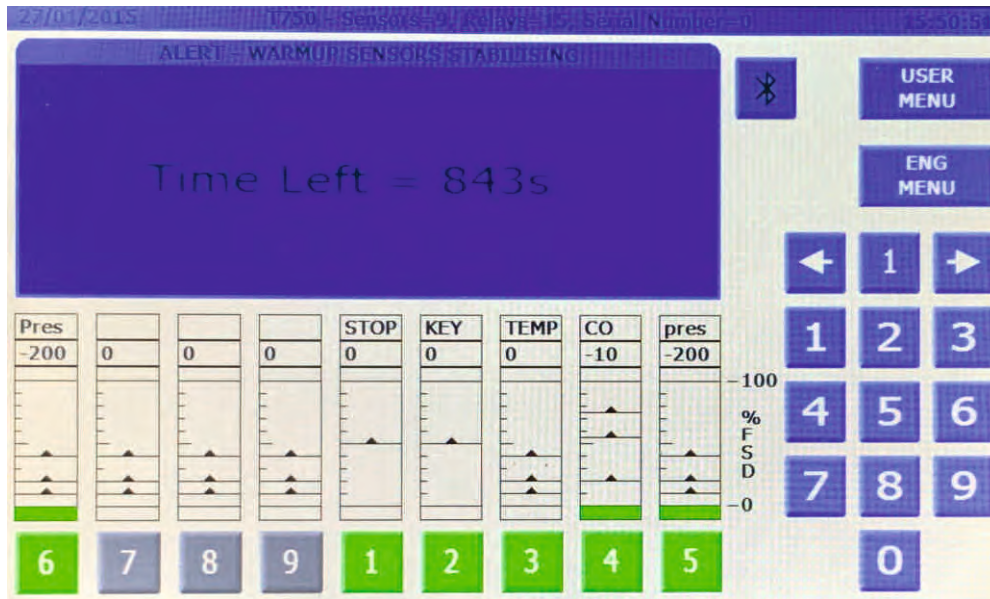

On initial power up the system will run a series of system checks and then start a stabilisation 'warm up' timer. For systems including Oxygen sensors this will be 15 minutes, other sensor types 5 minutes. During warm up alarm relays will be in their 'normal' non-alarm states. A modbus state is available to indicate warm up status.

System Display With the System Inhibited for service

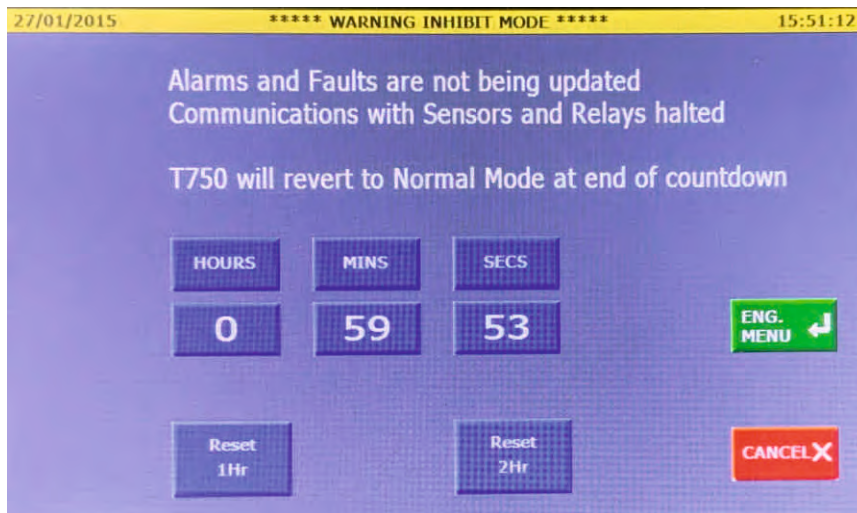

Entering Pass Code 25 will place the system into inhibit mode. Initially this will be for 60 minutes and can be terminated by selecting cancel at any time. During inhibit mode the system is not communicating to its detectors and so will not respond to them. Typically inhibit mode is used during system maintenance when Android/tablet IGD service tools are being used.

Alarm and fault relays remain in their normal state during inhibit mode and a modbus state is available to indicate the same.

If required a 2 hour period can be selected and it is also possible to enter engineer modes via this menu with the system still inhibited.

After the countdown the system will revert to normal operation.

System Display During Fault Detected

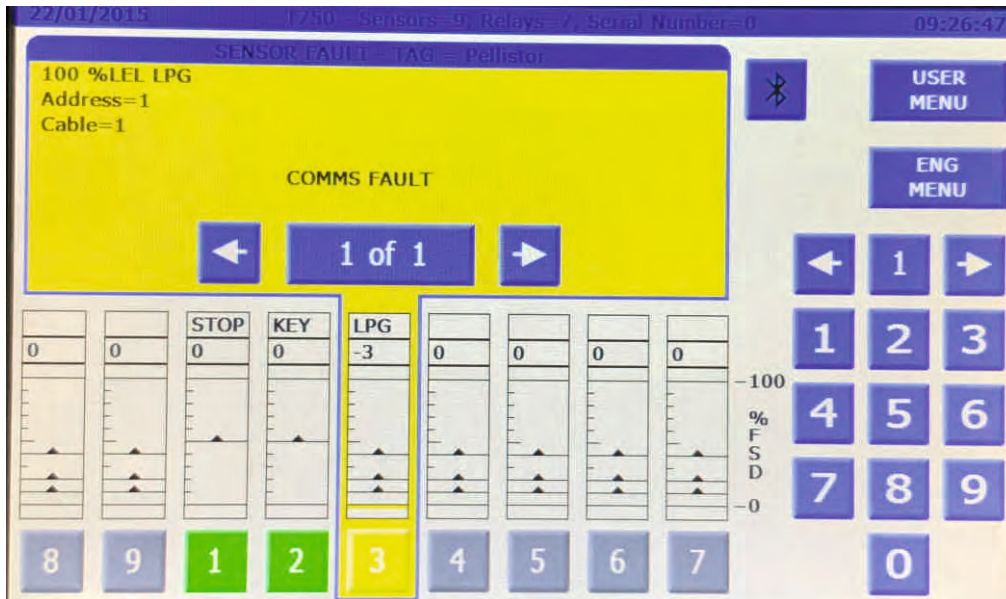

Faults are indicated on screen as a 'Yellow' display. Faults will be indicated against either the system or against the channel that has a fault. Alarms take precedence over faults but will still be indicated on screen at the side of the main display panel.

FAULT

State	Indication	State
Fault Communication	Comms Error Displayed 'Yellow'	Modbus State Available* Fault Relay Active Alarm Relays Normal
Fault Over Range	Channel/Display Indication Yellow	Modbus State Available* Fault Relay Active Alarm Relays Normal
Fault Under Range	Channel/Display Indication Yellow	Modbus State Available* Fault Relay Active Alarm Relays Normal
Fault Failed Self Test Processor Voltage	On Screen Display Indication Yellow	Modbus State Available* Fault Relay Active Alarm Relays Normal
Fault Failed Self Test Flash Memory	On Screen Display Indication Yellow	Modbus State Available* Fault Relay Active Alarm Relays Normal
Fault Failed Self Test RAM	On Screen Display Indication Yellow	Modbus State Available* Fault Relay Active Alarm Relays Normal

Required Setup Sequence

It is necessary to follow the correct setup sequence for the controller to function correctly, observe all permit to work or hot work permit systems etc. In all cases refer to latest revisions local wiring standard for example in the UK:

BS 7671	IET Wiring Regulations
BS 60079-14	Explosive atmospheres - Electrical installations design, selection and erection
BS60079-17	Explosive atmospheres - Electrical installations inspection and maintenance
SL-016	IGD 2-Wire Installers Guide (see IGD website for latest revision)
SL-035	IGB JB3 ATEX Junction Box Manual
SL-xxx	Latest revision controller, detector and device manuals (use latest revision)

1. Before commencing ensure that the controller is being fed via a suitable fused mains supply spur and that it has been correctly tested for polarity and Earth continuity.
 - a. For 150 and 300 Watt controllers fit a 3 Amp fuse
 - b. For 300 Bespoke systems ensure fuse sizing is correctly calculated
2. Ensure each detector cable leg has been tested for insulation resistance prior to connecting the controller and or nodes. Performing an insulation resistance test with detector and or the controller in circuit cause damage to the electronics, ensure only cable runs are tested.
- 3 Ensure all devices are terminated following instructions in the latest version 2-Wire installers guide. Make sure cables used are of the correct type and terminated correctly. Check all cable screens are continuous.
4. With all devices connected the controller can be powered. Check the following:
 - a. Adjust the PSU to 27.5V DC
 - b. Detector nodes should all be showing green power LED's
 - c. Use a suitably calibrated clamp meter to ensure highway power is less than 2 Amps
 - d. Check that a terminator is fitted to each cable highway and that end of line voltage is greater than 18V DC
5. Check each detector node for its base address and that the addresses do not clash with any other devices on the same highway. Resolve clashes by altering base addresses as necessary. Where ancillary devices such as beacon-sounders or mA input sensors are connected check the setup on the node is correct using an IGD dongle and IGD setup software.

7. Perform a **SENSOR FIND**. This will setup the correct sensor channel configuration and correct number of channels. Sensors will be allocated to channel numbers based on the lowest sensor address being allocated to the first available channel number and then sequentially thereafter. Note that the channel sequence can be adjusted afterwards using the **Re-order** function, to group sensors if required. Use the **Sensor Comms test** function to check for correct communication.
8. Perform a **RELAY FIND**, this will set up the correct number of system relays. Note that the relay sequence cannot be moved around in the same manner that the sensors can and **MUST** be programmed in the sequence they are found. If relays are moved around after a FIND then the alarm relay setup will still work but relay diagnostics will not perform correctly. The reason for this is that the diagnostic routines will expect relay addresses to be grouped, correlating to their devices. For example an 8 way relay card may number 110 to 118 but an annunciator may only be using one relay address. Mixing the single relay address into the sequence of an 8 way relay card will stop the diagnostic routine displaying and operating correctly. Use the **relay comms test** function to check for correct communication. **Relay Test** can be used to turn the installed relays on and off individually. This provides a method to test that the correct external devices are wired and function correctly to the expected system relay.
9. Use the **Alarm Relays** and **Alarm Levels** functions to determine and setup what triggers each system relay to perform the desired cause and effect. Note alarm relays can action on rising or falling levels, can be latching or non latching and can be normally on or normally off. In addition each relay can action on any or specific alarm levels. See specific sections in the manual regarding this.
10. Check through **System Options** to ensure all required global settings are correct, generally the defaults can be used. If options such as GSM Modems or Modbus communicating devices are connected then these options must be manually configured to operate correctly. See specific sections in the manual regarding this.
11. Use the 'Force Reading' function to ensure the programmed cause and effect operates as required including external interfaces to other systems.

12. Ensure the Event log is cleared. Addressable gas detectors are shipped pre-calibrated. This does not obviate the installer from testing each detector with a suitable calibration and zero gas to prove they a) function correctly b) meet calibration. If necessary re-calibrate any detectors that are outside +/-2% accuracy. Ensure detectors are fully warmed up before undertaking any checks. It is advised that detectors have been powered for at least 4 hours. Where test gases exceed the alarm set points, alarms that are activated will be stored in the event log which can be retained as part of the commissioning records

13. Once the system is operating correctly download the system setup via the embedded web page menu's as part of the commissioning record.

14. Use the system options menu to store a backup of the commissioned system setup onto the controller itself.

15. Use IGD Dongle and software to save detector calibration data where detectors have been re-calibrated otherwise store 'as shipped' calibration information.

16. Set calibration interval on the control panel, initially to 6 months.

Finally clear the system event log so that it only reflects future events.

The system is now fully operational.

The following pages discuss each menu option in turn.

The Engineer Menu (Passcode 50)

Select Engineer Mode and enter pass code 50
The following menu is then displayed



Select the tab at the top of the folder to access each section. Note that the sensor tab is displayed with its page options by default. Select the EXIT tab to return to normal operation.

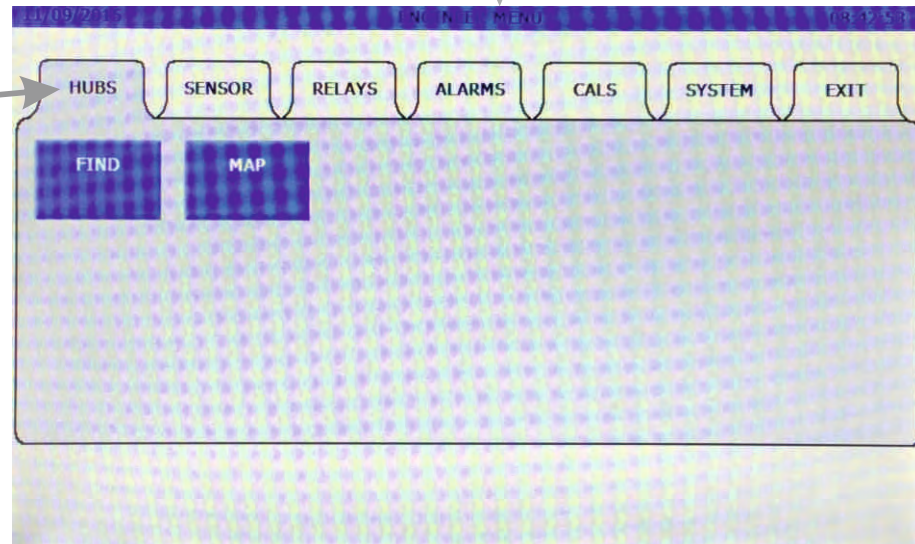

TAB GROUPS

FUNCTIONS

SENSOR

Sensor Channels (Change the number of active channels)
Sensor FIND (use to find addressable sensors)
Sensor Setup (setup channel parameters)
Sensor Test (Communication test function)
Sensor Diagnostics (Full diagnostics for the chosen detector)
Sensor Check (Sensor diagnostic Health Check)

RELAYS

Relay Channels (Change the number of system relays)
Relay FIND (use to Find addressable relays)
Relay Diagnostics (Communication test function)
Relay Test (Physical relay test)

ALARMS

Alarm Levels (set alarm levels for each detector)
Alarm Copy (copy alarm set up between channels)
Alarm Relays (Set up parameters for alarm activation)

CALS

Zero Sensor (Use to zero an individual sensor)
Zero All Sensors (Zero all connected sensors)
Calibrate Sensor (Calibrate an individual sensors)
One Man Calibration (one man walk round calibration)

SYSTEM

Main global system settings
GSM Setup (Use to set up GSM functions)

EXIT

|GSM Test (Test GSM operation)

Exit to normal gas detection operation

System Menu Access and Options

The Tocsin 920 operating system has two access levels for set up and maintenance functions. The basic menu layout is indicated on the diagram below.



Note that the User Menu items are repeated on the Engineer Menu. For the balance of this manual only the engineer menu functions are discussed.

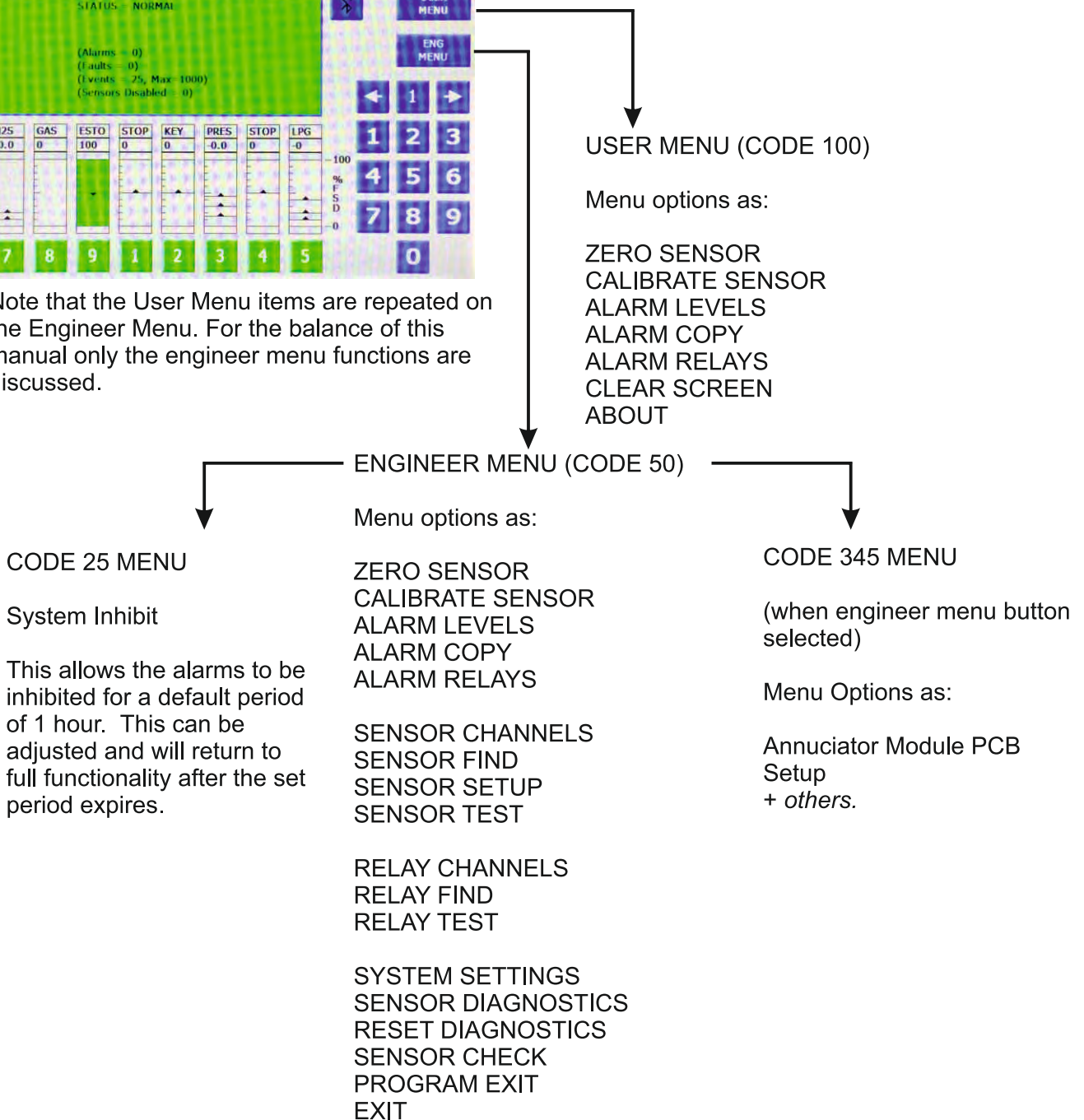

Operational Set up Philosophy

The Tocsin 750 controller forms the operational core of an addressable gas detection system.

ALL elements of the system such as detectors, highway hubs, relay outputs etc have addresses on the system.

During set up and commissioning the inputs and outputs to and from the Tocsin 750 are defined with their addresses.

The diagram below shows a typically hierarchy.

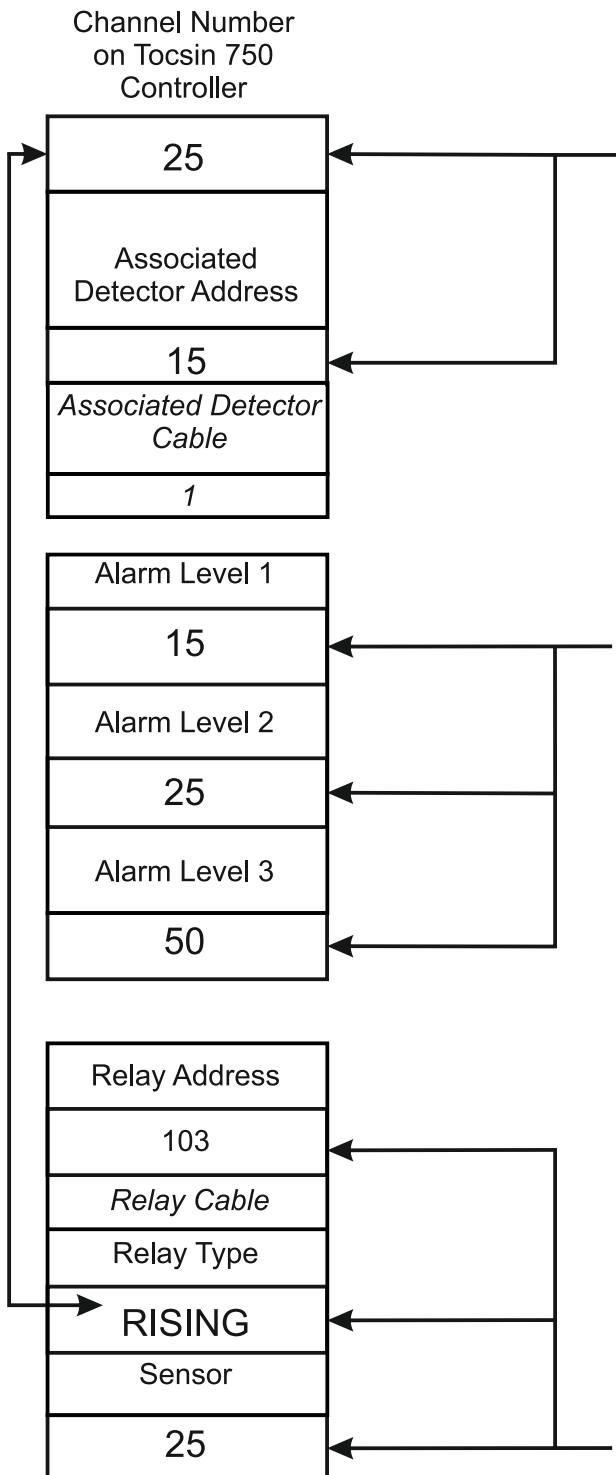

In this example for this particular channel (25) on the Tocsin 750 controller the gas detection readings are coming from detector 15. This is setup in the SENSOR SETUP menu.

The required alarm levels are set up in the ALARM SETUP menu. Three alarm levels are possible for each channel as AL1,AL2 and AL3. The type of alarm is also setup in this menu as one of either:

RISING ALARM

Alarm on rising gas level once set point is exceeded. Alarm resets after gas level is below the alarm point.

RISING LATCHING ALARM

Alarm on rising gas level once set point is exceeded. Alarm must be manually reset after gas level is below the alarm point.

FALLING ALARM

Alarm on falling gas level once level is below set point. Alarm resets after gas level is above the alarm point.

FALLING LATCHING ALARM

Alarm on falling gas level once level is below set point. Alarm must be manually reset after gas level is above the alarm point.

These options are configured in the RELAY SETUP menu which allows relay alarm outputs to be assigned to particular channels or groups of channels. For complete details on alarm options see the Alarm Setup Menu section later in this manual.

The Sensor Setup Menu

Tap here to enter the on screen tag for the detector (max 32 characters)

For this channel enter the address which is to relate to this channel.

Select gas FLAMM, CO, CO2 etc

Enter the UNITS to display. % LEL, ppm,%Vol etc

Enter the hub cable number that this detector is installed onto. Note the first hub is cable numbers 1 to 4.

Select to temporarily enable or disable a channel

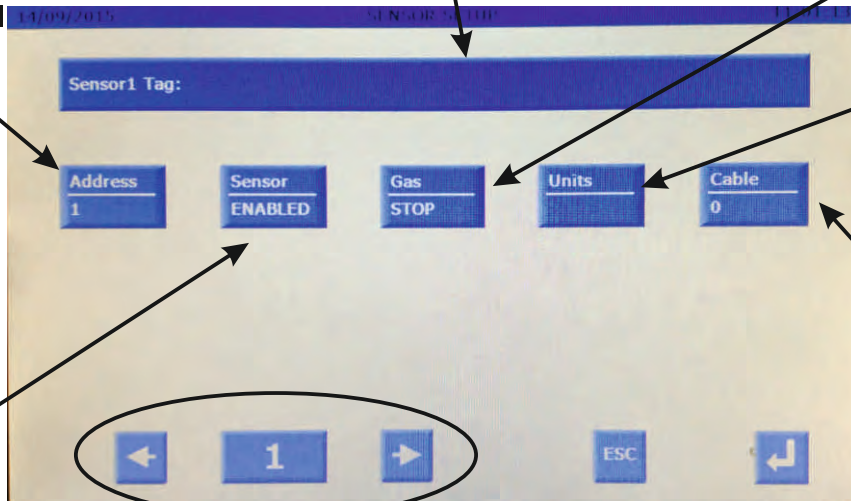

Select to move between channels. Tap on the channel number to type in the channel number if known.

Note that when a set up button is selected a popup menu appears to allow data to be typed into the set up box.

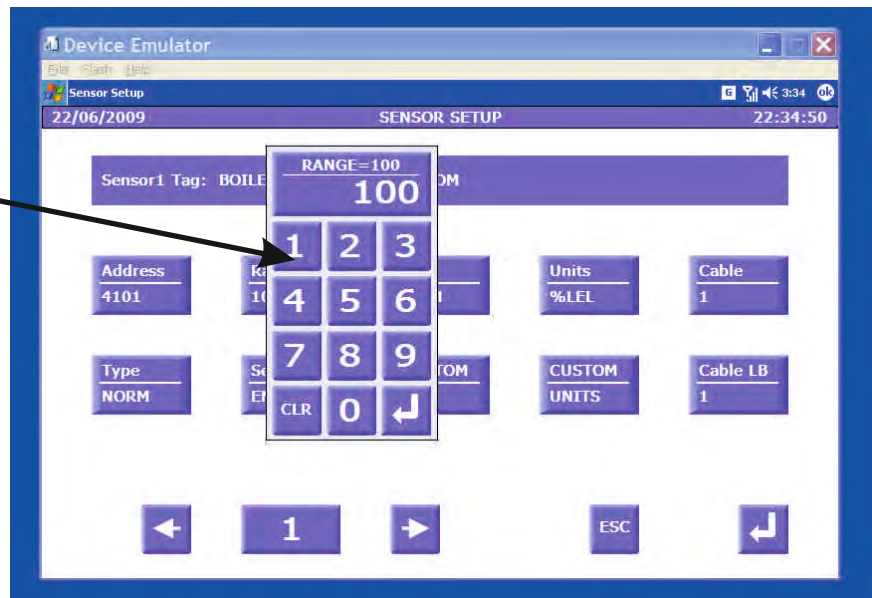

Notes

The Sensor Setup Tab

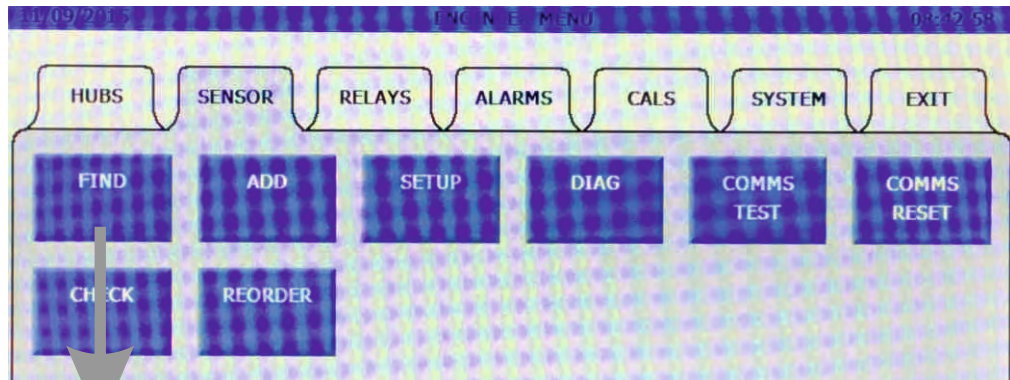

The Sensor FIND Function

The sensor FIND function is used during initial set up of the system to test that all connected detectors communicate to the control panel. The function can also be used to automatically install onto the panel all of the detectors which are 'found'. By doing this channels are automatically set up on the controller for the Address, Cable, Range, Gas Type etc. This will speed channel set up but it should be noted that performing a FIND and auto install will erase all the existing set up information including alarm levels and alarm action types.

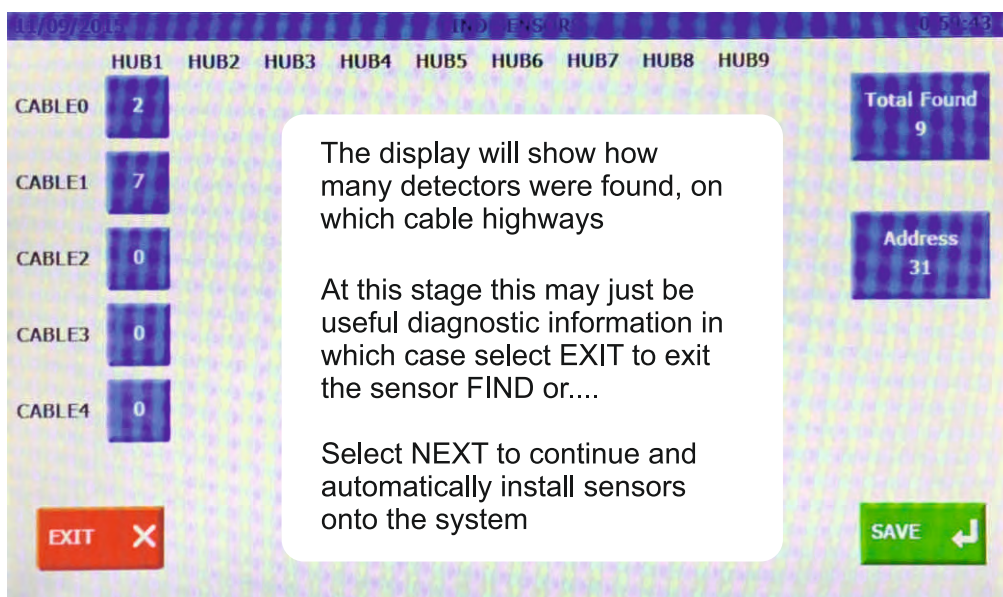
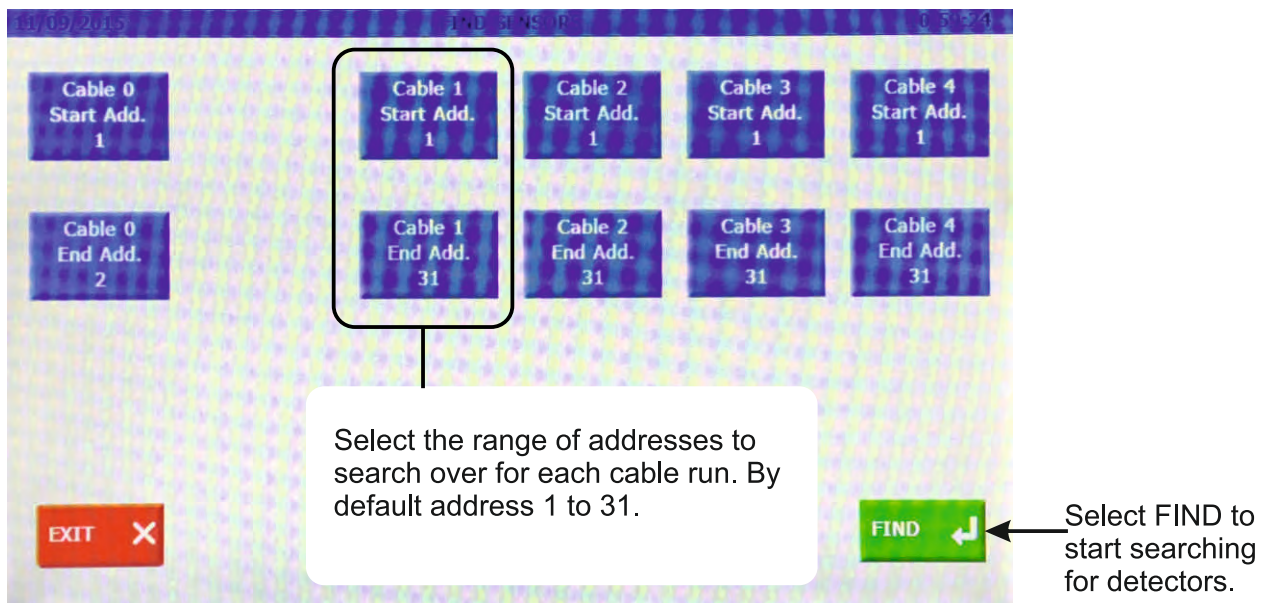

The Sensor Test Function

The sensor comms test function is a diagnostic check which provides information regarding the ability of the Tocsin 750 controller to communicate to all its connected detectors.

To run the test, select the range of channels you wish to test and then how many communication cycles to run the test for (typically 1000).

When sensor test is selected the following diagnostic screen is displayed.

The display shows eight sensor channels at a time. Use the NEXT and PREVIOUS keys to display more channels. The return key ends the diagnostic.

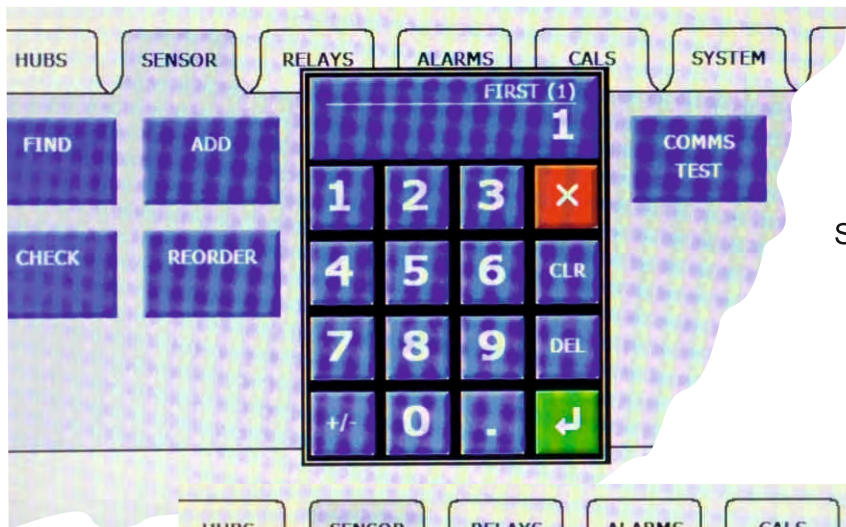

Select the starting channel

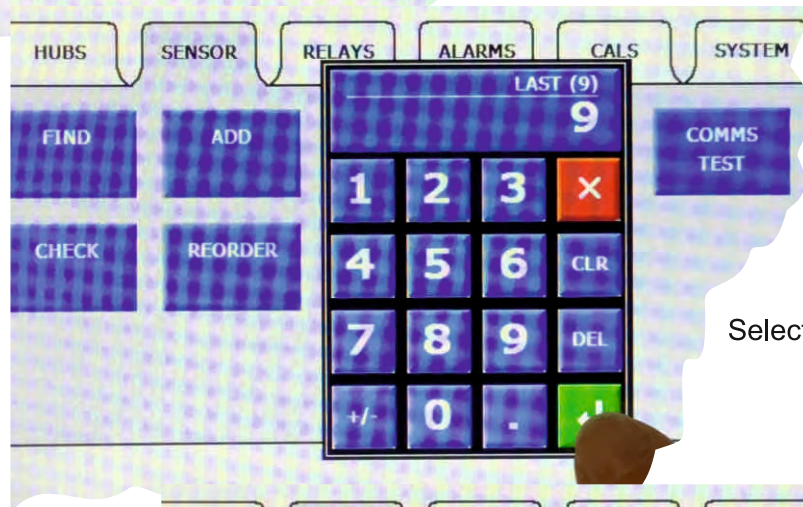

Select the Finishing Channel

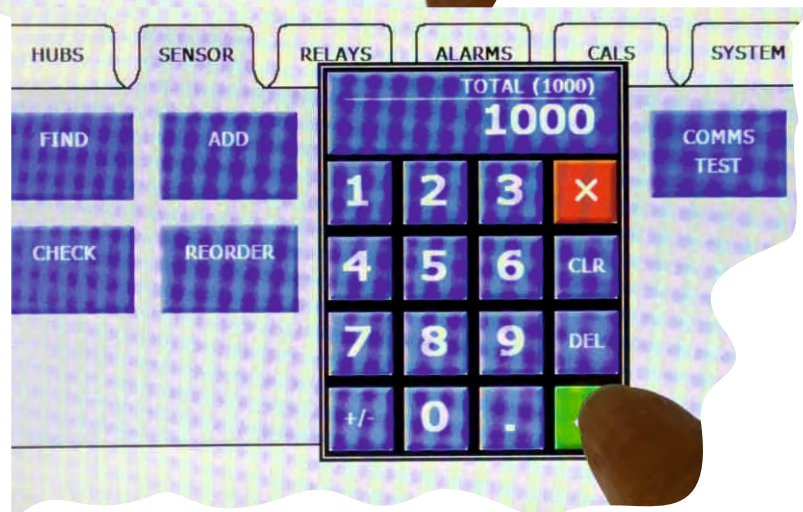

Select how many communication cycles to run the test for.

The Sensor Test Function

	RUNNING (6%)		Errors				Totals		
	Tx	Rx	Timeouts	Command	CRC (Corr)	% Err	Tx	% Err	mS
S1	64	64	0	0	0 (0)	0.00	18739	0.00	0
S2	64	64	0	0	0 (0)	0.00	18739	0.00	0
S3	64	64	0	0	0 (0)	0.00	18739	0.00	8
S4	64	64	0	0	0 (0)	0.00	18739	0.00	6
S5	64	64	0	0	0 (0)	0.00	18734	0.03	8
S6	64	64	0	0	0 (0)	0.00	18739	0.00	6
S7	64	64	0	0	0 (0)	0.00	18738	0.01	8
S8	64	64	0	0	0 (0)	0.00	18739	0.00	6
S9	64	64	0	0	0 (0)	0.00	18739	0.00	7

Sensor Channel Number

Number of Data Transmits

Number of Data Receives

Response Time <10mS

Transmissions and error rate since last reset
Overall errors rate should be <0.5%

Errors detected as an overall percentage of Tx transmissions for this test run

Checksum Error
Data Packet Corrupted

Command Errors
Data Packet Correct But Not The One Expected

Number of time outs. i.e detector did not respond quickly enough to request for data from Tocsin 750.

Note that the overall percentage error rate should be less than 0.5%.

Anything greater than this is indicative of a problem requiring correction. Usual errors arise from poor cable termination, *duplicate address*, *low highway voltage* or poor cable screening and should be corrected prior to final commissioning.

Sensor Diagnostic Functions.....Diagnostics

The sensor diagnostics function provides a snapshot of an individual sensor channel for evaluation should there be a problem.

The screen shot below is indicative of the information typically available.

The Live Data Panel

Conc	Live gas concentration from the detector
Volts	Gas reading as a voltage from the detector
Pink	Only for pellistors, the active volts signal
Temp	Detector Temperature
Press	Ambient Air Pressure
Zero Drift	Zero Drift Compensation Volts
Fault	Any reported errors
Zero T.Comp	Zero Temp Compensation Volts
Cal T.Comp	Cal Temp Compensation Volts
Cal P.Comp	Pressure Compensation Volts

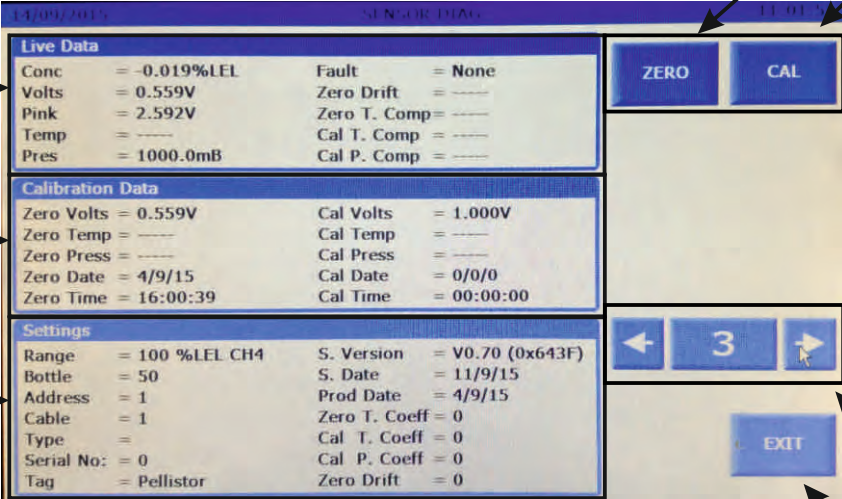

Zero Detector Routine (see Zero section)

Calibrate Detector Routine (see Calibrate section)

Detector zero and calibration sensitivity functions and calibration gas settings. These should only be accessed by trained and competent personnel.

Channel Navigation

EXIT to main menu

Settings Data Panel (information only)

Type	Detector Type
Range	Detector Range
Gas	Detector Target Gas
Address	Detector Address
Cable	Cable on which detector is installed (highway)
Software	Detector Software Version
Serial No	Detector Serial Number
Prod Date	Detector Production date

Calibration Data Panel (information only)

Zero Volts	Recorded Zero Voltage from last successful zero normally 1.0V +/-0.1V (Applicable for T102A V3.00 or previous)
Zero Date	Date of last successful zero
Cal Volts	Recorded Cal Voltage from last successful calibration. Note this is proportional to the gas value and range of detector. For example zero = 1V Half Scale = 1.75V Full Scale = 3.5V (approx values) (Applicable for T102 A V3.00 or previous.)
Cal Date	Date of last successful calibration

The Relays Tab

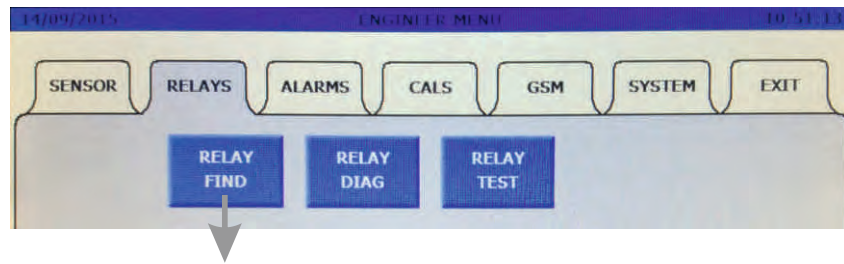

The Relay FIND Function

This function is similar to the sensor FIND function and is used to detect addressable relays installed onto the data highways. The opening screen allows you to limit which highways (cable numbers) you wish to search over and limit the range of addresses. Selecting FIND initiates the search for the selections you have made. **You have to FIND relays for the relay diagnostic functions to work correctly**

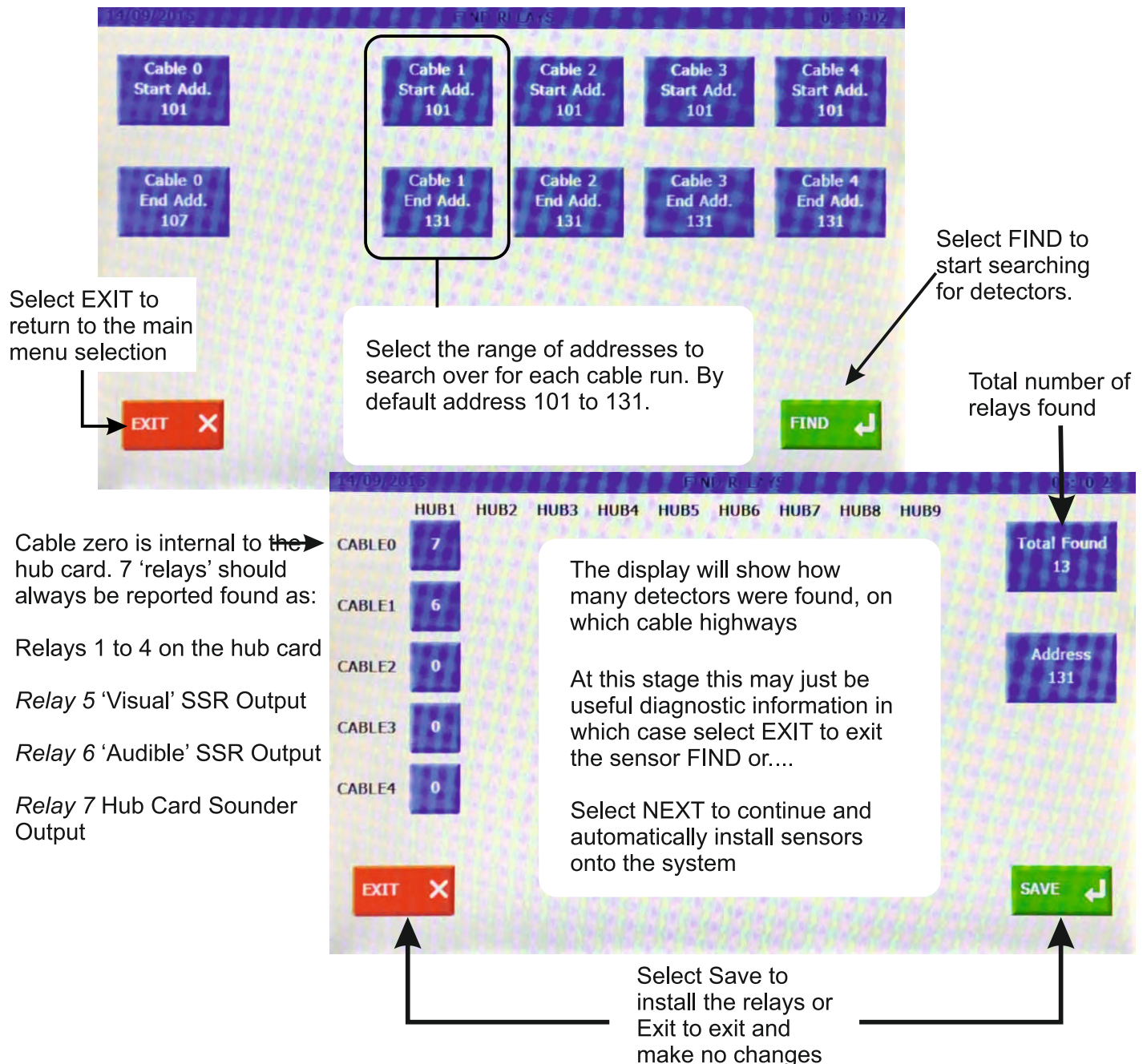

Select EXIT to return to the main menu selection

Select the range of addresses to search over for each cable run. By default address 101 to 131.

Select FIND to start searching for detectors.

Total number of relays found

Cable zero is internal to the hub card. 7 'relays' should always be reported found as:

- Relays 1 to 4 on the hub card
- Relay 5 'Visual' SSR Output
- Relay 6 'Audible' SSR Output
- Relay 7 Hub Card Sounder Output

The display will show how many detectors were found, on which cable highways

At this stage this may just be useful diagnostic information in which case select EXIT to exit the sensor FIND or....

Select NEXT to continue and automatically install sensors onto the system

Select Save to install the relays or Exit to exit and make no changes

	HUB1	HUB2	HUB3	HUB4	HUB5	HUB6	HUB7	HUB8	HUB9
CABLE0	7								
CABLE1	6								
CABLE2	0								
CABLE3	0								
CABLE4	0								

Total Found: 13

Address: 131

The Relay TEST Function

The relay comms test function is similar to the detector comms test. This function is a diagnostic check which provides information regarding the ability of the Tocsin 750 controller to communicate to all its connected detectors.

To run the test, select the range of relays you wish to test and then how many communication cycles to run the test for (typically 1000).

When relay test is selected the following diagnostic screen is displayed.

The display shows eight relay channels at a time. Use the NEXT & PREVIOUS keys to display more channels. The return key ends the diagnostic.

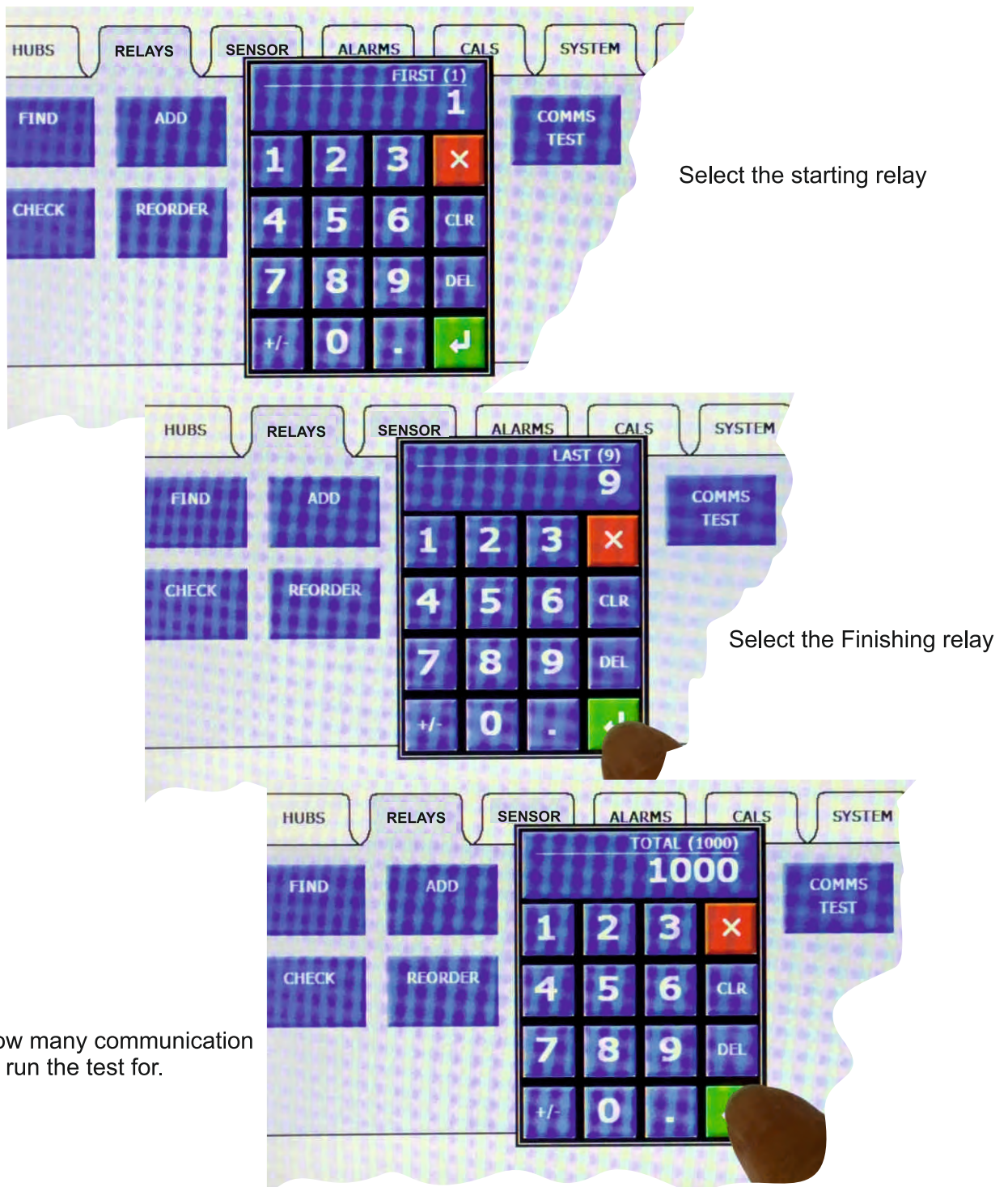

The Relay Diagnostics Function

RELAY (MMS E J F n I T J) Total= 000) 06 3 06

RUNNING (9%)			Errors				Totals		
	Tx	Rx	Timeouts	Command	CRC (Corr)	% Err	Tx	% Err	mS
R1	90	90	0	0	0 (0)	0.00	260054	0.00	0
R2	90	90	0	0	0 (0)	0.00	260054	0.00	0
R3	90	90	0	0	0 (0)	0.00	260054	0.00	0
R4	90	90	0	0	0 (0)	0.00	260054	0.00	0
R5	90	90	0	0	0 (0)	0.00	260054	0.00	0
R6	90	90	0	0	0 (0)	0.00	260054	0.00	0
R7	90	90	0	0	0 (0)	0.00	260054	0.00	0
R8	90	90	0	0	0 (0)	0.00	260052	0.00	8
R9	90	90	0	0	0 (0)	0.00	260052	0.00	6
R10	90	90	0	0	0 (0)	0.00	259901	0.06	8
R11	90	90	0	0	0 (0)	0.00	260054	0.00	6

Navigation buttons: Left arrow, 1, Right arrow, EXIT X

Relay Number

Number of Data Transmits

Number of Data Receives

Response Time <10mS

Transmissions and error rate since last reset
Overall errors rate should be <0.5%

Errors detected as an overall percentage of Tx transmissions for this test run

Checksum Error
Data Packet Corrupted

Command Errors
Data Packet Correct But Not The One Expected

Number of time outs. i.e detector did not respond quickly enough to request for data from Tocsin 750.

Note that the overall percentage error rate should be less than 0.5%.

Anything greater than this is indicative of a problem requiring correction. Usual errors arise from poor cable termination or poor cable screening and should be corrected prior to final commissioning.

Relay Test Function

The Tocsin750 has the option to run a relay test function. Select the option and the following screen is displayed.

Note the outputs on the hub card are always indicated first

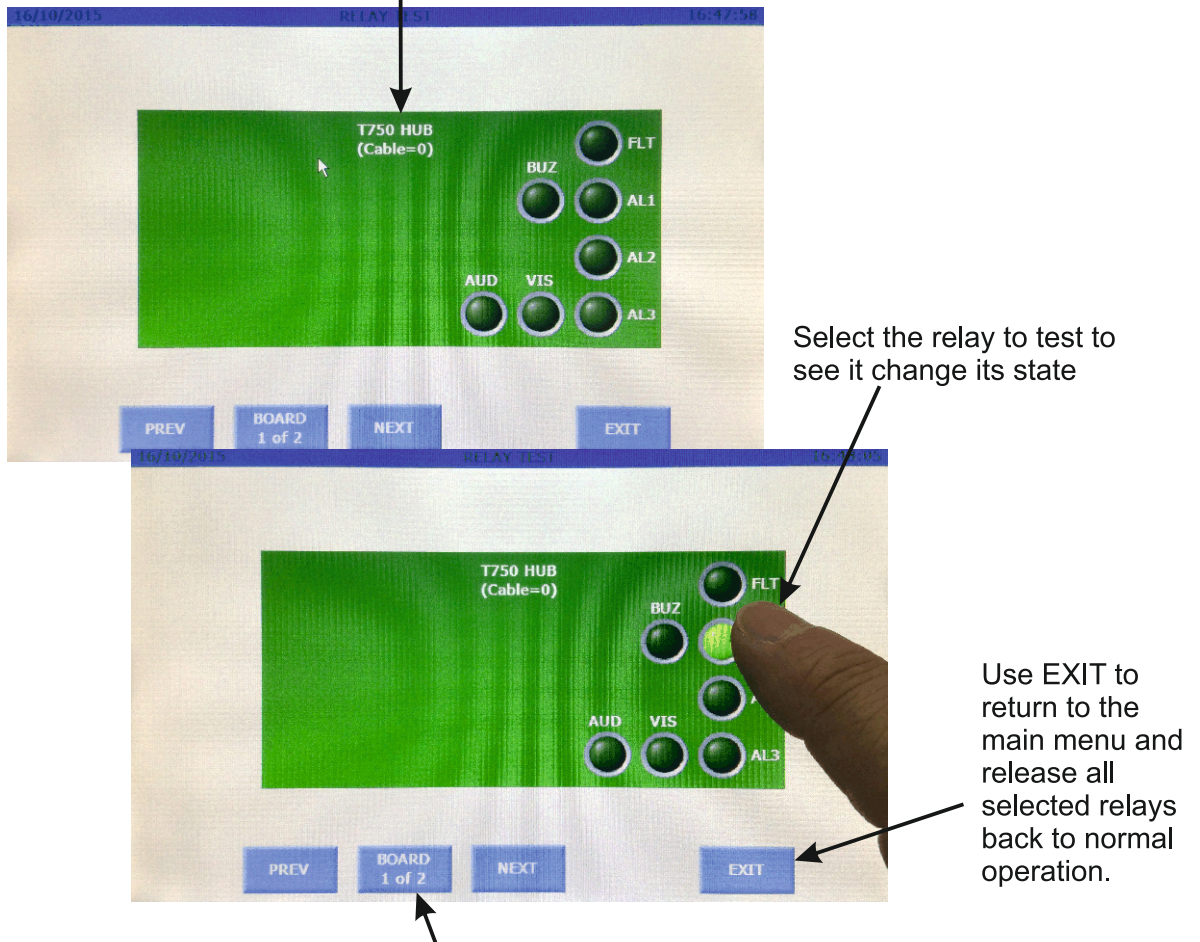

Use the NEXT and PREV buttons to select the desired relay board.

There are also screen displays for individual 'module' outputs.

Cable Highway

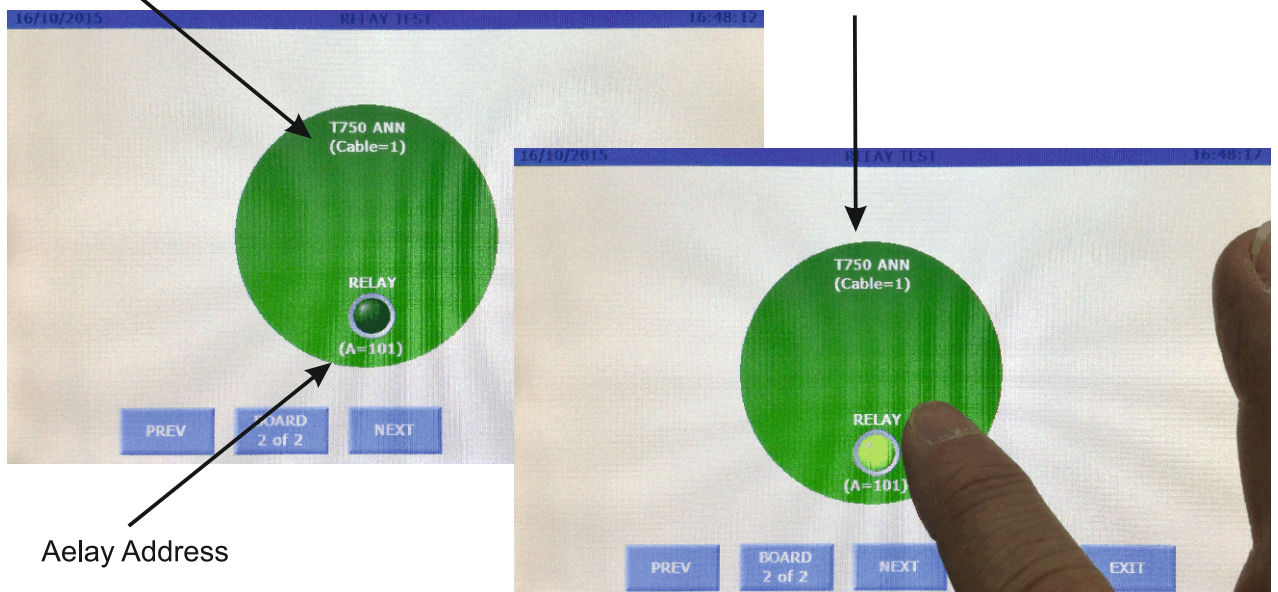

The Alarms Tab

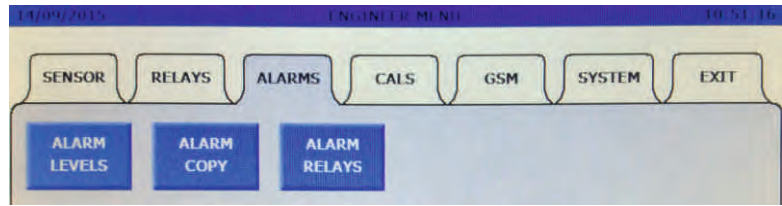

The Alarm Levels menu

The Tocsin 750 allows 3 alarm levels to be set per sensor channel. This is set up in the alarm levels menu selection and is indicated in the screen shot shown below. See note below for recommendations for hazardous gas detection.

Set the alarm levels for AL1, AL2, AL3

Set alarm levels to default values

Set the alarm action for AL1, AL2, AL3
Options are:
Rising
Rising Latching
Falling
Falling Latching

Use the arrow keys to navigate between channels or type in the channel to be edited

ESC returns the system to the menu selection screen without making any changes.

select the enter key to update your changes to the system.

If alarm devices, output contacts or alarm signal outputs are provided as part of continuous duty gas detection equipment and are intended to operate when a potentially hazardous gas concentration is detected, they shall be of a latching type requiring a deliberate manual action to reset. If two or more alarm set points are provided, the lower may be non-latching - based on user preference. Alarms shall remain in operation while the alarm condition is still present, although audible alarms may be silenced if this audible alarm is not the only alarm.

Recommendations for maintenance after measuring range exceeded

Allow to stabilise in clean air or use instrument air at 0.5L/Min for 4 hours. If reading is greater than 5% LEL after this period replace otherwise re-zero and calibrate

Notes

The Alarm Relay Setup Menu

The alarm relay setup on the Tocsin 750 controller is based on the relay rather than the detector/channel. For each relay output connected on the system the following set up page must be configured to allow the system to determine when a relay is triggered.

Set the alarm relay TYPE as:

- DISABLED
- AL1
- AL2
- AL3
- AL1 or AL2 or AL3
- AL1 and AL2
- FAULT

Set the Relay Address

Set the Cable Number onto which the Relay is Installed

Set if the Relay is to be Energised or De-Energised on Alarm Activation

Set if the Relay can be Muted or not From the Control Panel

Type	Address	Cable Pri	Cable Sec	Energised	Mutable		
AL2	103	0	0	YES	NO		
FROM (1)	FROM (2)	FROM (3)	FROM (4)	FROM (5)	FROM (6)	FROM (7)	
1	0	0	0	0	0	0	
TO (1)	TO (2)	TO (3)	TO (4)	TO (5)	TO (6)	TO (7)	
9	0	0	0	0	0	0	
SENSOR	SENSOR	SENSOR	SENSOR	SENSOR	SENSOR	SENSOR	
0	0	0	0	0	0	0	
SENSOR	SENSOR	SENSOR	SENSOR	SENSOR	SENSOR	SENSOR	
0	0	0	0	0	0	0	
RELAY							
EXIT X	DISABLE	←	3	→	SAVE ↵		

Use to Disable Relays

Use to Save the Relay Setup

Use the return key to save changes and the ESC key to exit without making any changes. Navigate either by typing the relay number or using the left and right keys.

Use the FROM - TO boxes to select groups of sensors, for example From sensor channel 1 To sensor channel 6 to activate this relay on alarm. Up to 7 sensor groups can be defined in this way. Note in all cases that for these groups of sensors the relay will be active only for whichever alarm level, AL1,2 or 3 is defined in the relay TYPE.

In addition to the FROM - TO sensor groups, individual channels can also be added into the relay activation definition. Up to 14 individual sensor channels can be added to the definition. Note in all cases that for these sensors channels the relay will be active only for whichever alarm level, AL1,2 or 3 is defined in the relay TYPE.

The Calibration Menu

It is recommended that after installation the system is commissioned by an IGD qualified service engineer. The service interval is 6 months including calibration of all connected gas sensors by a suitably qualified service engineer.

1. Sensor Zero

Select this option to Zero a particular sensor.

The expected sequence will be:

Select ZERO SENSOR function

Select the channel to ZERO

Flow zero gas at the sensor and allow to stabilise

Select to ZERO

Observe the result

See enclosed Zero-Cal Data

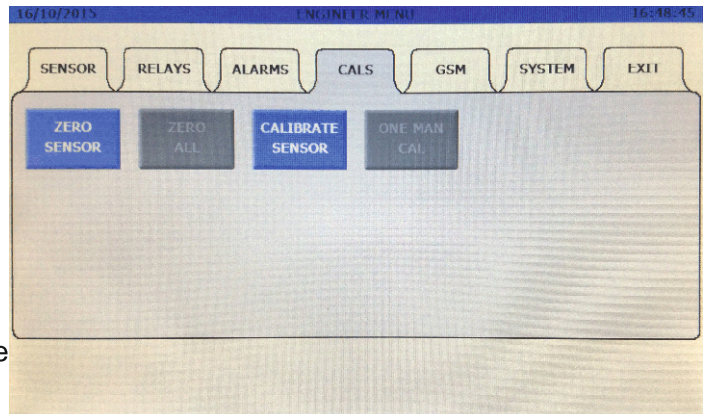

2. Zero All

Selecting this function will automatically perform a zero on all connected detectors. Typically this is only used during commissioning when it is known that there is no target gas present. This function should NOT be used in general calibration as there is the danger when an installation is up and running that you could be zeroing off a valid gas reading.

3. Calibrate Sensor

Select this option to Calibrate a particular sensor.

The expected sequence will be:

Select CALIBRATE SENSOR function

Select the channel to CALIBRATE

Flow calibration gas at the sensor and allow to stabilise

Select to CALIBRATE

Observe the result

See enclosed Zero-Cal Data

4. One Man Calibration

This function allows one person to calibrate a sequence of detectors by selecting the function then applying gas to each detector in turn for 3 minutes. The Tocsin 920 monitors the signal from the detectors and performs the calibration automatically once it sees a valid steady reading. This is similar in operation to the walk test function on a smoke detection panel.

For full details see later section.

The Sensor ZERO Function.....continued

Select the Zero function from the Engineers menu and the following screen is displayed.

Flow zero gas and observe the reading. Once stable select the ZERO button to send the zero command to the detector head. Observe the ZERO reading to ensure it has returned the detector to zero reading. $0\% \pm 2\%$ of Range

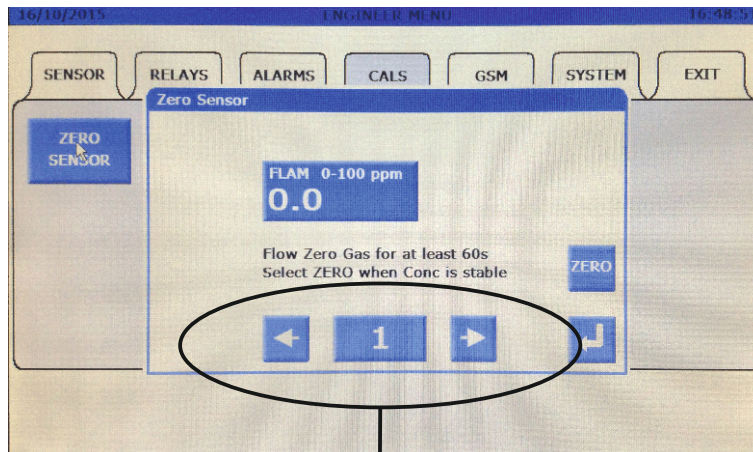

Select to move between channels. Tap on the channel number to type in the channel number if known.

Procedure for check reaction time to gas

Ensure detector is at zero $\pm 1\%$ LEL
 Use standard IGD professional gas introduction kit with 2M hose.
 Connect calibration gas but do not turn on
 Using a stop watch turn on the calibration gas and time to 50% and 90% LEL
 Time to 50% should be less than 30 seconds
 Time to 90% should be less than 60 seconds

Note on a 20% LEL bottle T50 point is 10% LEL and T90 point is 18% LEL
 on a 50% LEL bottle T50 point is 25% LEL and T90 point is 45% LEL

replace non conforming sensors

The Sensor ZERO Function

Zero and calibration functions should only be undertaken by trained competent personnel. The effectiveness of a gas detection system is largely down to how well it is maintained and this means how well it is calibrated.

Apply zero gas to the detector.

It is important that the detector zero point is correctly set. It must be considered that there is the possibility that the gas to be detected is already present in the area of the detector. For this reason never zero on just the ambient surroundings.

Use a suitable ZERO gas as follows. Zero gas should have a humidity between 0-90%RH

GAS	RECOMMENDED ZERO GAS
O2/CO2	NITROGEN
PELLISTOR	INSTRUMENT GRADE AIR
TOXIC GASES	INSTRUMENT GRADE AIR

The following diagram shows a typical equipment set up.

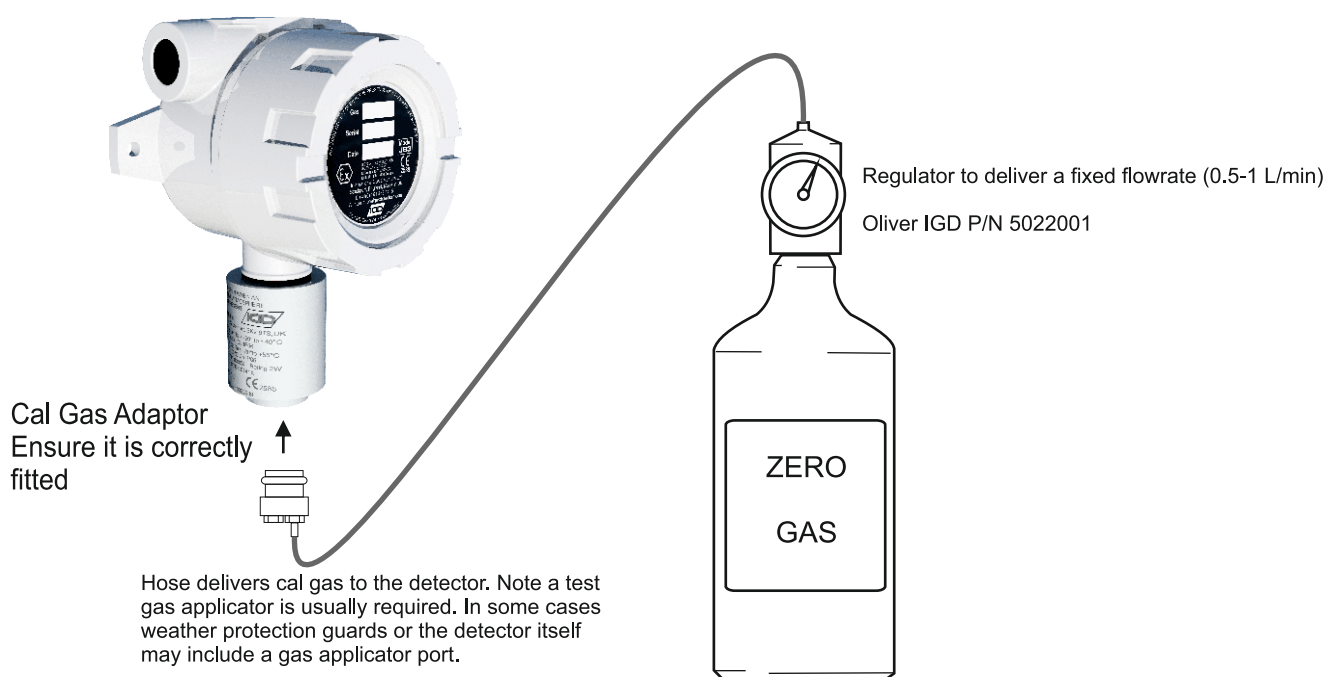

IMPORTANT: Flow gas for a minimum of 60 Seconds. Some detectors with longer response times may take longer to stabilise.

Recommended Test 750 series Gas Applicators.

Tocsin 102 Series Detector P/N 401101A

MK3 Gas Detector P/N 401101A

MK5 & MK6 Gas Detector P/N 401101E

TOC-750 Series P/N

The Sensor CALIBRATE Function

Calibration is a similar process to the ZERO command and also requires a suitable calibration gas.

Note that with calibration there is more to consider than with Zeroing. The type and age of the detector can have an influence so it is recommended that periodically as well as calibrating the detectors that their response is checked in the diagnostic menu. In this manner over a period of years detector deterioration can be checked for preventative replacement. For full details refer to the IGD 750 Series detector manual.

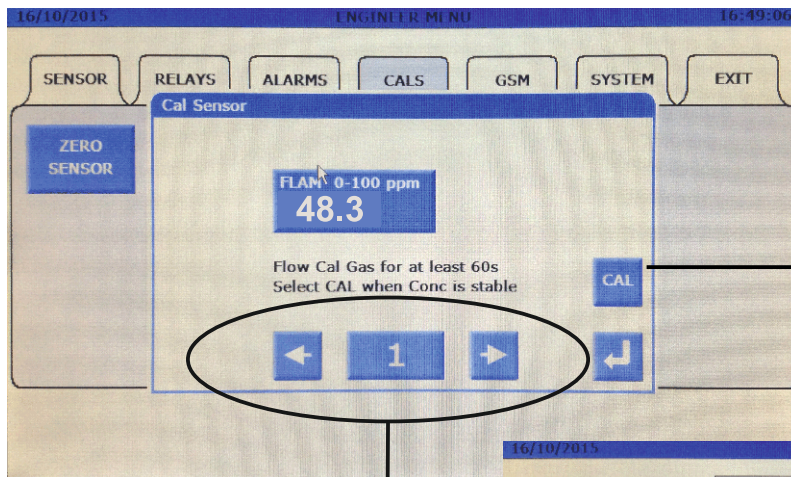
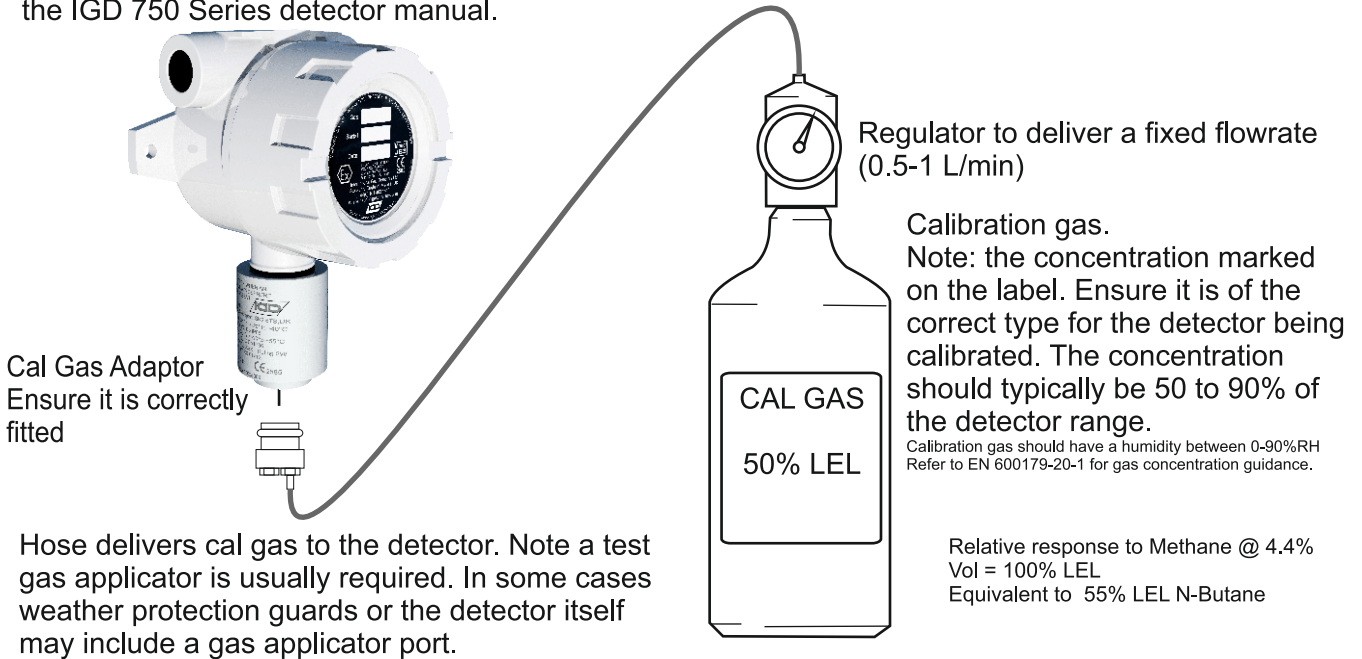

Flow calibration gas and observe the reading. Once stable select the CAL button. The option now appears to enter the calibration gas value. This will normally be written on the calibration gas bottle label. The calibration command is then sent to the detector head. Observe the calibrated reading in the following screen to ensure a successful calibration (typically +/-2% of Range).

Select to move between channels. Tap on the channel number to type in the channel number if known.

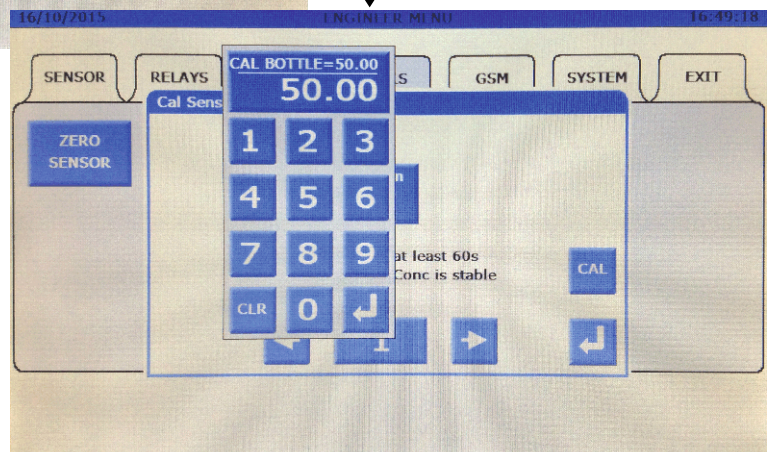

Forcing a Channel Input

During commissioning it is often required to check that the programmed alarm setup responds correctly. Rather than having to introduce calibration gas or use a signal generator to simulate a programmed input the controller can be used to 'Force' an input. Select the Production Menu and then the 'Sensor Force' option.

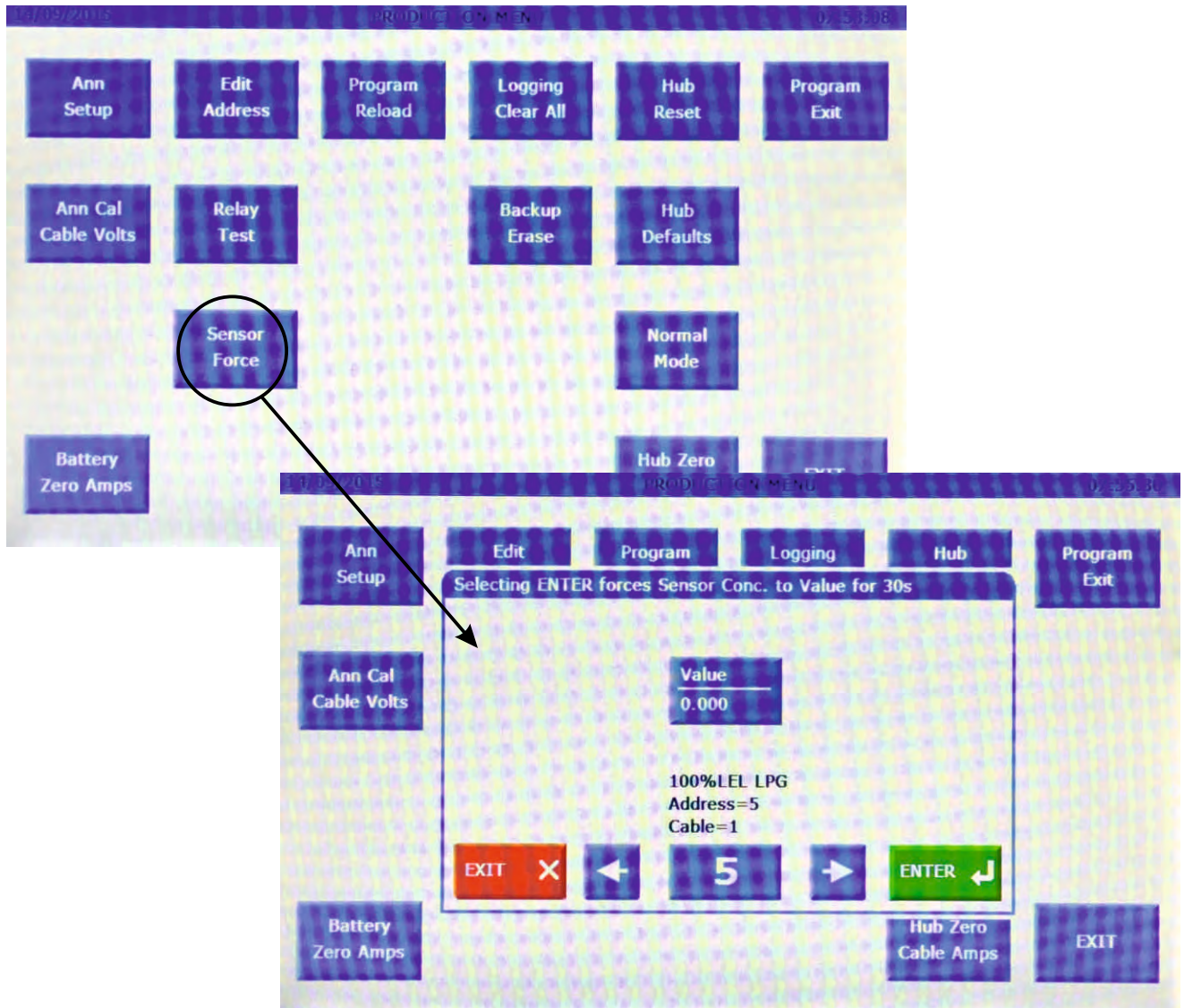

Select the channel to force and then enter the required value. With the correct channel and value displayed, selecting enter will force that level onto the selected channel for 30 seconds. This allows testing of the alarm configuration without having to use test gas or signal generators.

Note that the gas detection system is operational in the background whilst you are in the menu system. Any sensor input that is 'forced' will therefore still activate the alarms. If required once a sensor is forced you can Exit back to the main screen to observe the 'forced action' on screen.

Backing Up Panel Setup Internally

The controller can create an internal backup of the controller setup file. This option is located in the System menu. Select Backup from the system menu tab and backup options are indicated as shown below.

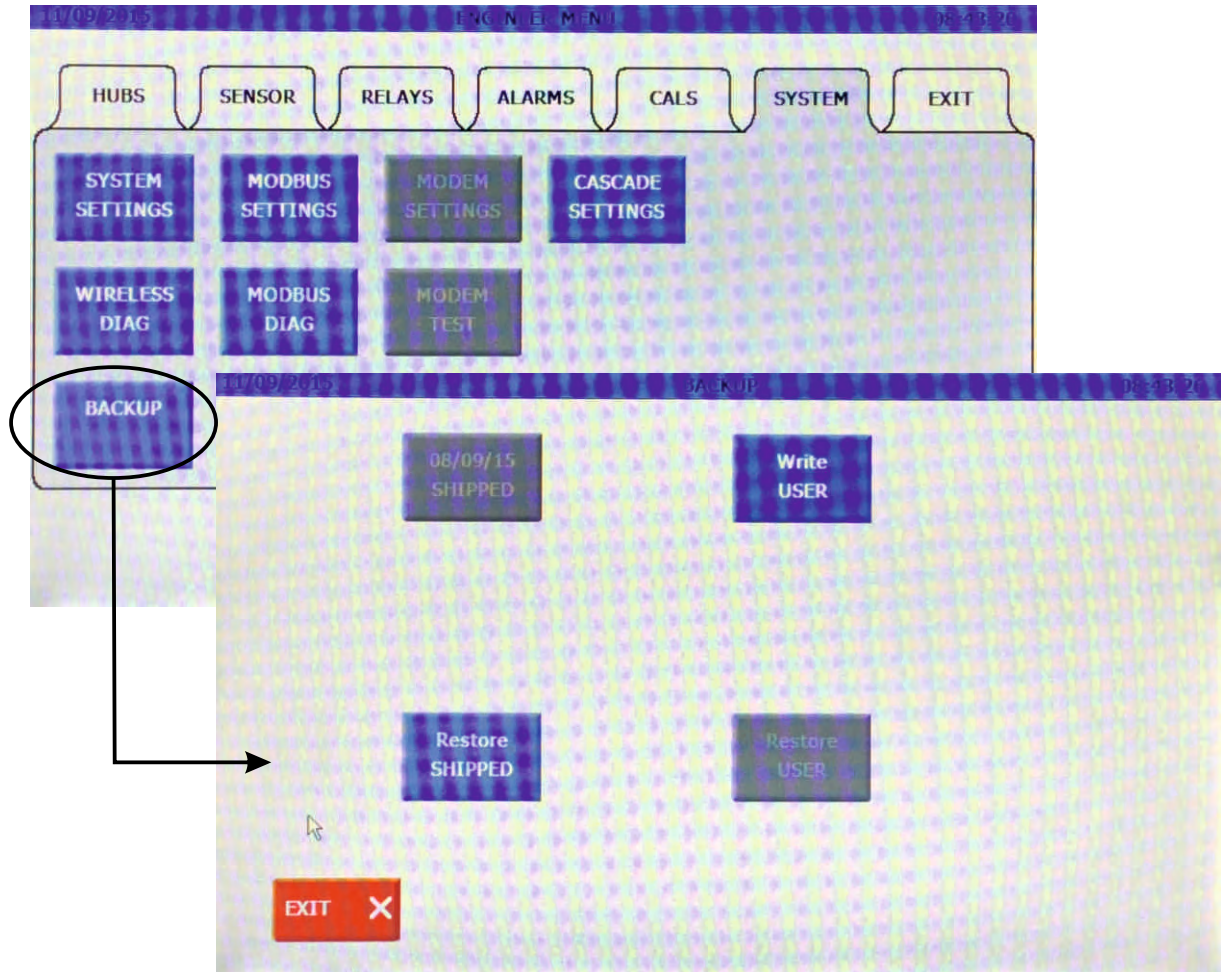

If the controller was shipped with a factory configured alarm setup then the 'as shipped' backup will already be saved. This is indicated in the screen display shown above. This setup can then be restored at any point by selecting 'Restore Shipped'.

If the setup has been modified during commissioning then this setup can be saved independently of the as shipped setup. In this case selecting 'write User' will save this commissioned state as a backup.

Either of these setups are then available to be re-loaded at any time.

The backups can be erased by accessing the production menu.

Power Function

Selecting the 'Power' function from the system menu tab provides an overview of the system voltages, battery (if fitted), power supply and start and end of each cable highway. This is a useful diagnostic tool.

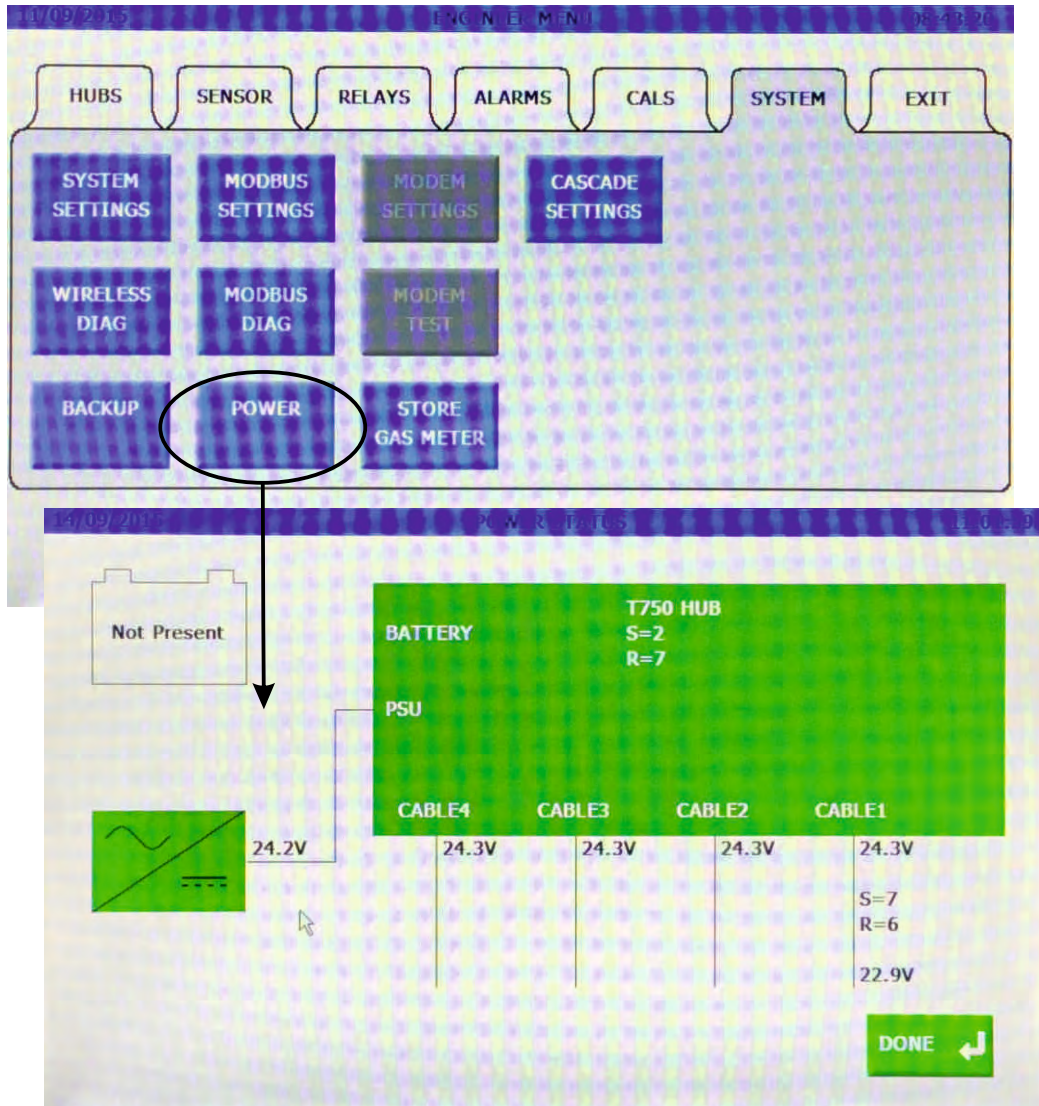

Modbus Settings

The controller can have its own Modbus address if is to be part of a larger monitoring system (BMS etc). Selecting the eModbus option from the System Settings tab gives access to modify these settings

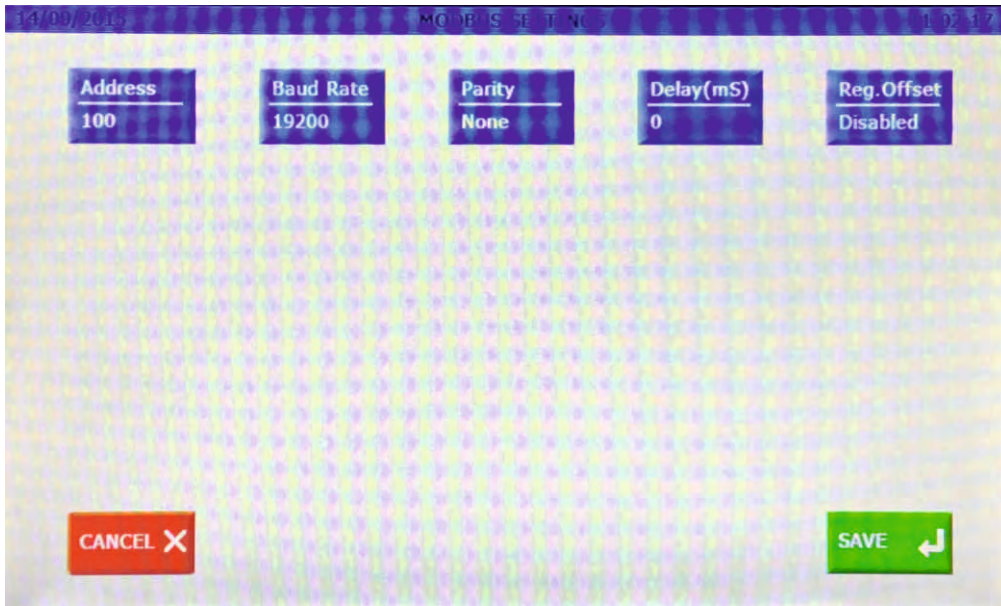

Modbus Diagnostics

A modbus diagnostic feature is also included such that information is displayed to see incoming data requests and controller responses.

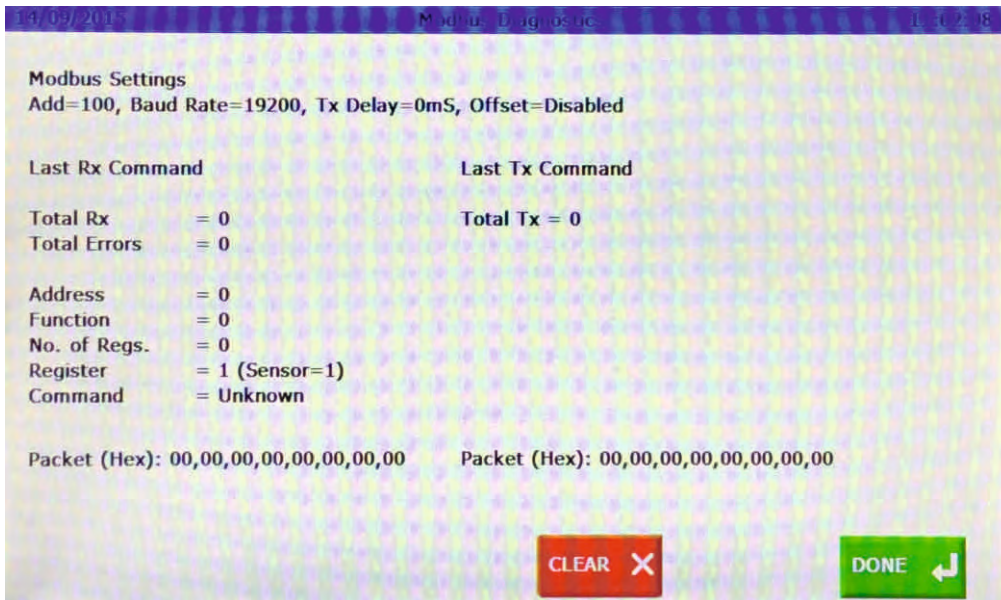

GSM Module Functions

GSM functions are available via the system options menu. Note this feature requires a GSM module to be fitted to the controller with a data only or M2M SIM card. The SIM card must be valid for the chosen service provider. The GSM module is a factory fit module. Note that the GSM module utilises the RS485 modbus port.



Enable the Modem option

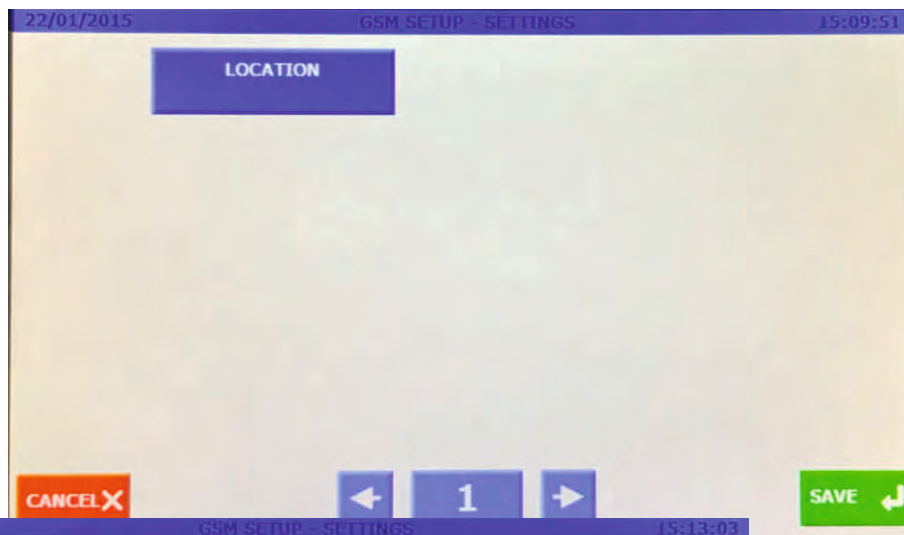

Select the Modem Setup Option.

Screen 1 allows a location for the site or controller to be entered. This tag line/name will be transmitted along with any alarms/reports.

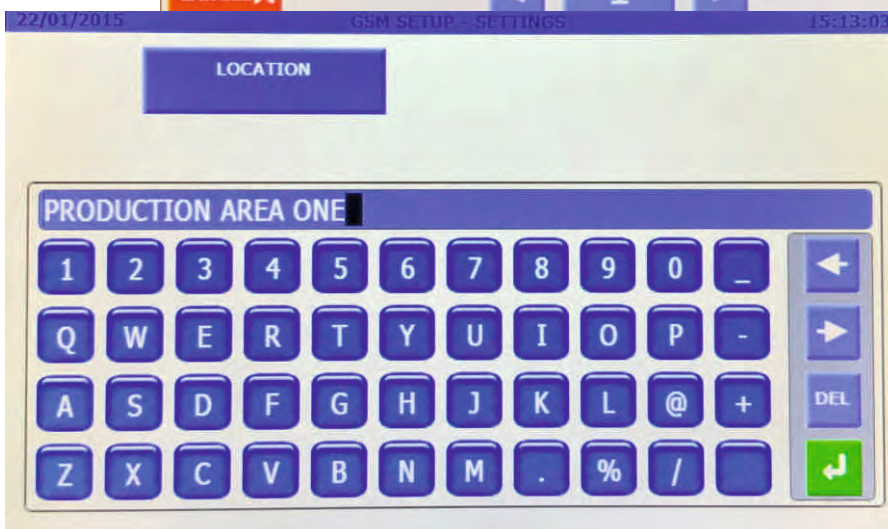

GSM Module Functions

Settings on this screen should be provided by the SIM card/mobile service provider.

An Access Point Name (APN) is the name of a gateway between the GSM module and the mobile network provider.

Settings will be particular to each provider and are either provided with the SIM card or can be found via the internet or provider help desk.

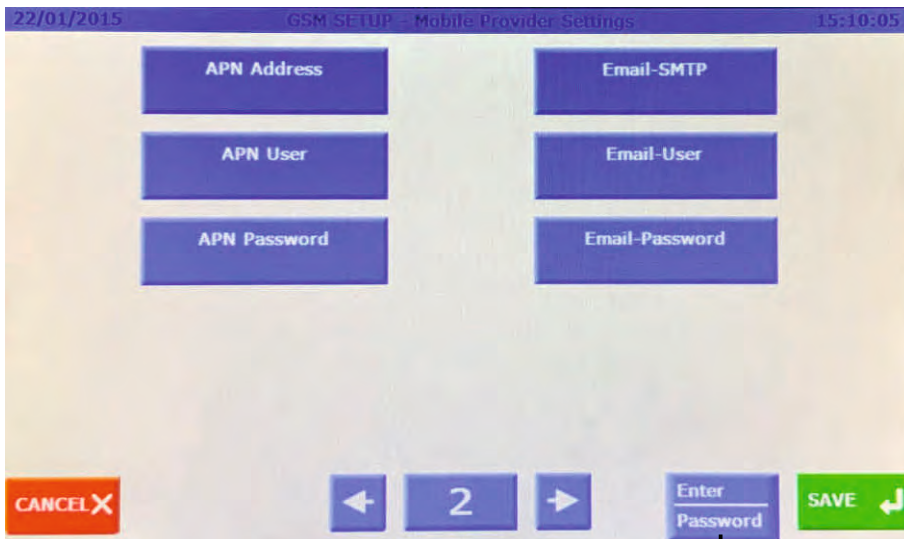

Changing these settings is under password control normally configured by the commissioning engineer

Typical Settings, in this case using O2 as the provider

APN Name	o2.co.uk
APN User	o2web
APN Password	password
SMTP	mail.O2.co.uk
SMTP User	<i>Your O2 Email Address</i>
SMTP Password	<i>Your O2 Email Password</i>

Note that Authenticated email is NOT supported

GSM Module Functions

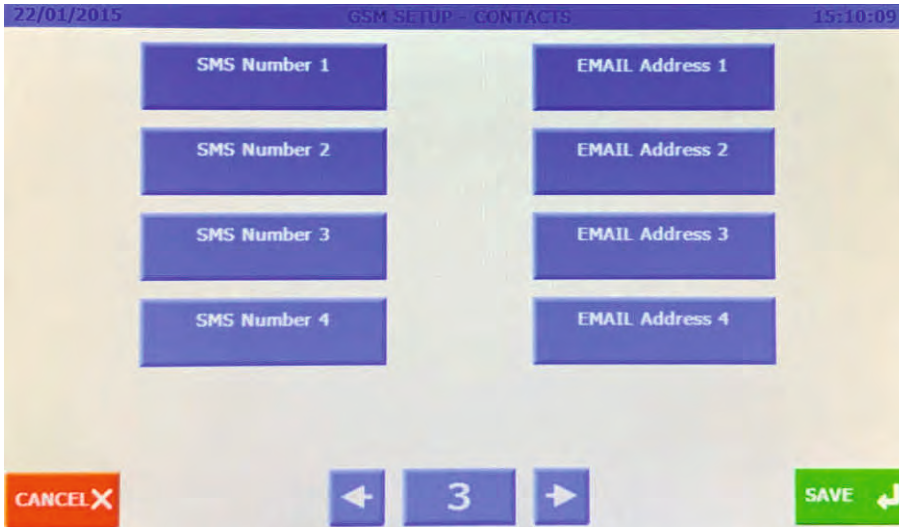

Screen 3 allows entry of up to 4 SMS numbers and email addresses. These can be selected later to decide which SMS/emails get alarms and reports as required.

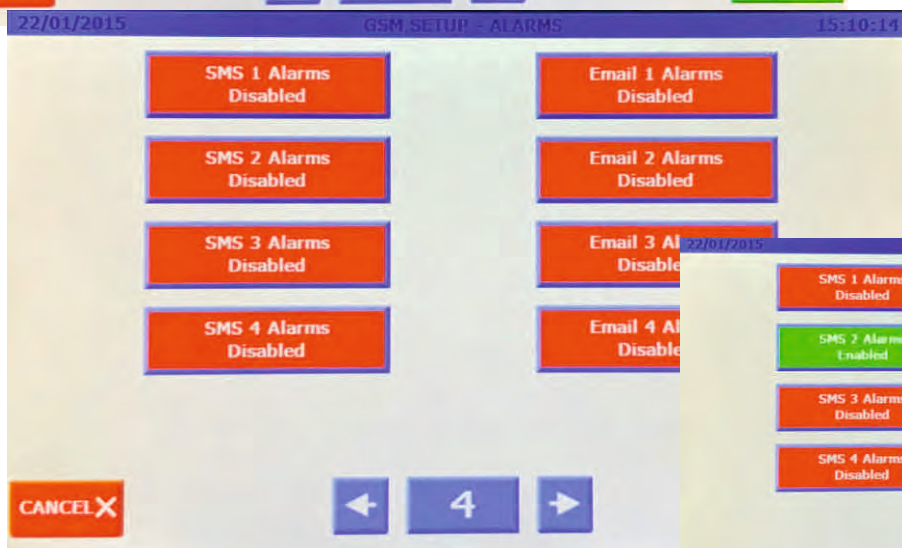

Screen 4 allows you to select which of the entered numbers or addresses is active or disabled.



Screen 5 is used to select which SMS or email address (accounts) gets a 'Gas Values' report.

This is a snap shot of the gas values taken and then sent to the selected accounts.

Note the interval can be selected and the time

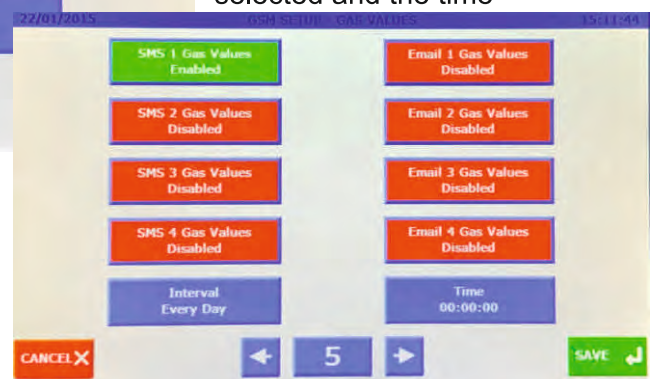

GSM Module Functions



Screen 6 is used to select which SMS or email address (accounts) gets an 'Events' report.

Events will be listed time and date stamped to indicate:

Alarms, Alarms Muted, Alarms Reset
Faults
Calibrations

Note the interval can be selected and the time



Screen 7 is used to select which SMS or email address (accounts) gets a 'Sensor Check' report.

Sensor check provides a calibration status and health status of each detector on the system.

Note the interval can be selected and the time



GSM Module Functions

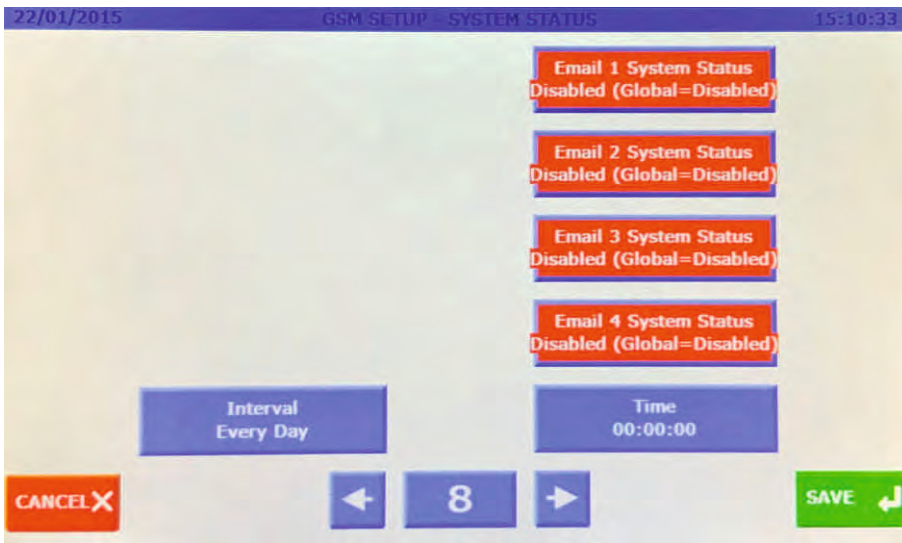

Screen 8 is used to select which email address (accounts) gets a 'System Status' report.

The system status report is a general overall report on the system health.

Note the interval can be selected and the time



Screen 9 allows selection to enable selected SMS users interaction with the system.

To use these features requires training from IGD to fully understand implications of taking each action remotely.

These functions are only recommended to be used by trained IGD engineers. As such detail of remote SMS commands are not included in this manual.

GSM Module Test Functions

A selection of test and diagnostic functions are available to test the function of the GSM system as follows:

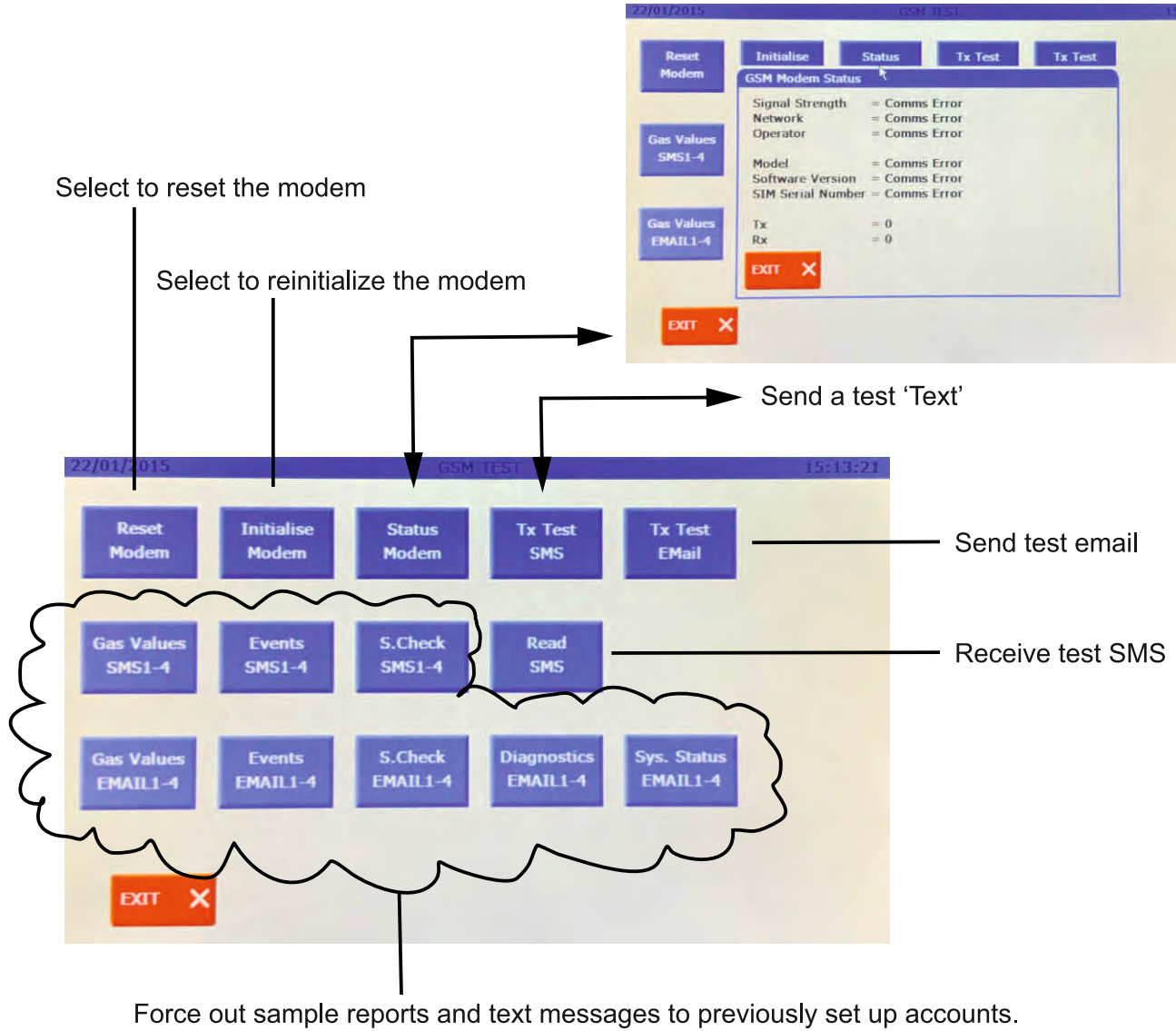

Troubleshooting

Possible fault	Possible reason	Possible solution
The detector cannot be turned on	No power supply	Connect power supply
	Panel failure	Please contact IGD
	Fault of electric circuit	Please contact IGD
No response to the gas	Warm up is not finished	Wait till warm up is finished
	Electrical Fault	Please contact IGD
Inaccurate indication	Sensor is overdue service and calibration	Please contact IGD for service and calibration
	Damaged sensor	Please contact IGD
Fault indication	Error Message	Reboot system
	Error Message after re-boot	Please contact IGD
Minus gas level displayed	Gas sensor drift	Calibrate zero point
Sensor fault indication	Sensor fault	Please contact IGD

Standard accessories Supplied

- 1 x Terminator Set (5 off)
- 1 x Resistor Pack
- 1 x Diode Pack
- 1 x Snubber

Accessories

Part Number	Description
5083101	Beacon Sounder Amber/Red
508150	Beacon Sounder Red
5083160	Beacon Sounder Blue
401101B	Cal Adaptor (Tocsin 103)
401101Z	Cal Adaptor (Zirconia)
401103	Cal Adaptor (MK5/6)
4011109	Gas Adaptor (TOC-30, TOC-10)
401451	Splash Guard (Tocsin 103)
401452	IGD Splash Guard
401465	Protection Filter Disk
5110101	Remote Gassing Port
5134601	40mm Stop Button
5138601	Collector Cone Ring Lock
5138701	T103 Splash Guard
5138801	Collector cone kit (MK6)
TOC-GLAND	M20 Snap fit cable glad
5925801	Universal Pole Clamp
TOC-750-DIO	Free wheel diode pack
TOC-750-HMI	Remote HMI display
TOC-750-IO2	8 Channel Relay Card
TOC-750-SNB	Contact Suppressor (Snubber)
TOC-750-TRM	Terminator set
TOC-GAS-KIT	Bump Test Kit
5137201	Professional Calibration Kit 1
5142301	Professional Calibration Kit 2
5124601	Professional Calibration Kit 3